

Evolve Power Beam

Effective July 14, 2025 – USA

Revised April 1, 2026

Project checklist

- Call Mark and review sc
- Finalize order process
- Launch schedule review with

PRICE LIST
evolve power beam



evolve systems



ISO 14001:2004 Registered
CGSB #006b



level™
the BIFMA sustainability standard
SCS-SCF0245-4
SCS-SCF0245-4

PROTECTING THE ENVIRONMENT FOR FUTURE GENERATIONS

Our environmental success story began with the challenge to create an office system that would meet today's business requirements while maintaining a firm commitment to save and protect the environment.

Sustainability became a part of the creative focus and development of Evolve that incorporates the latest technology and design features to provide excellent performance at a competitive price.

As government and industry environment ratings such as LEEDS & Greenguard become more prevalent, Evolve offers designers and architects functional, attractive, and economical office designs that meet these standards.

Evolve is a leader in reducing waste in the manufacturing of its products as well as utilizing recycled materials wherever possible. We make extensive use of recycled plastic and wood waste from other Global factories.

Evolve is committed to the continuous improvement of our environmental systems, the prevention of pollution, and to comply with both the spirit and the letter of all relevant environmental legislation.

Evolve Panels are 100% recyclable at the end of their lifespan. Nothing from an Evolve Panel needs to end up in a landfill.

PRODUCT INFORMATION

Evolve offers fabrics that are made from 100% recycled polyester, which means less waste going to landfills. These fabrics also reduced the demand for petroleum products, and decrease the environmental impacts of processing those petroleum products into polyester.

Evolve has developed a Panel interior made from 100% recycled wood and polypropylene. Through innovative design and technology, Evolve utilizes waste that would have normally been sent to landfill.

Evolve Panels are insulated with Roxul, a mineral wool insulation made from slag, an inert steel by-product, and basalt rock. Roxul is a high density product that provides maximum sound absorption to reduce noise in the work environment. Roxul insulation is fire resistant, water repellent and will not support the growth of fungi or mildew.

Evolve's epoxy powder coating process involves no liquids and is solvent free. It contains no harmful VOC's or lead. Up to 99% of over sprayed powdered is reclaimed, mixed with virgin powder and reused.

BEAM

Power Beam

- All metal components are painted with environmentally friendly epoxy powder.
- Raceway Interiors are coated with recycled epoxy powder.
- The entire Evolve Power Beam and the processes used to manufacture it are designed to save and protect the environment. Evolve panels are made from recycled materials and are 100% recyclable.
- Components conform to CGSB and ANSI/BIFMA Standards
- The quality and performance level of these panels have been tested to equal or exceed the requirements of the U.S. Government.
- Power Beam has a steel frame and is 2 7/8" thick. Corner posts create a panel creep of 3 1/4".
- Leveling Glides extend 1 1/2" high.

Power Beam Options

- Power Beams are available in the following heights: 24", 30", and 36".
- Module widths come in seven (7) sizes: 36", 42", 48", 54", 60", 66" and 72"
- Straight, 90 Degree & 120 Degree

Extension Module Options

- Acoustic Fabric (Tackable), Glazed, Open, Laminate, Whiteboard, Air Flow.
- Attaches to the top of the Power Beam or another extension module (not to exceed 42"h above finished floor).
- Offered in 6", 12", and 18" heights
- Can be stacked up to 42" high above the finished floor (A.F.F.)

Beam Reconfiguration

- Extension Modules can be modified on site by replacing fabric modules with Glazed, Open, Laminate, Whiteboard or Air Flow at any time after the initial installation.
- Fabric can be replaced easily; using pre-cut segments of fabric, a drawstring (C-Jex) is sewn in around the edges. Then a rubber spline is used to 'screen' the fabric in place.

VOICE/DATA AND ELECTRICAL POWER

- NOTE: Panels and Electric components are CSA/UL approved. Tools are not required to install electrical in the Power Beam.

Electric Information

- Electric can be run in all three Power Beam heights (24"h, 30"h or 36"h)
 - 8-Wire, 4-Circuit Capability
 - 2 Utility + 2 Dedicated Circuits
 - 10 Gauge (oversized) Neutrals
- All circuits can support up to 20 amps (15 CSA)
- Contact Evolve customer care for additional wiring options.

Raceway Information

- Raceway knockouts sizes conform to the ANSI/TIA/EIA Furniture Opening Standard of 1.38" x 2.71".
- Power Beam raceway is available at 36"- 72" wide.
- 36"- 60" - 2 electric / 1 data on each side.
- 66" & 72" - 4 electric / 1 data on each side. (When specifying 4 duplexes on one side 2 i-connectors are required per side.)
- Standard data face mount plates can be used without the need of adapter plates (supplied by others).
- **Cabling Capacities** (calculations below are based on .25" diameter communication cables.)
- **Power Modules**
 - Without Electric – 65 Cables
 - With Electric – 54 Cables
- **Panel Connectors - 90 Degree Connector Posts**
 - Without Electric – 45 cables
 - With Electric – 25 Cables

WORK TABLES

Freestanding Tables

- Foli height adjustable (23" or 29"d)
- Bungee (20", 24" or 30"d)
- Junction (20", 24" or 30"d)
- 2gether (18" or 24"d)

- **Power Beam is a freestanding beam system and does not support attachment of an Evolve brackets or overhead storage including cantilevers or other support brackets.**

WARRANTIES AND PERFORMANCE

- A Lifetime Warranty
- Non Obsolescence Warranty
- Reduced cost of assembly and reconfiguration
- ISO9001:2000 Registered
- ISO14001:2004 Registered
- GreenGuard Certified
- ANSI/BIFMA CGSB testing on all products
- For piece of mind over the long term, we cover you with a comprehensive warranty that is supported by our dealer network.
- Some installation companies claim that the Evolve Panels System can be installed in half the time it takes to install most of our competitor's segmented panels. This cost saving can amount to thousands of dollars over the lifetime of our furniture.
- Your assurance of consistent quality to an international standard. Evolve Systems is committed to design, manufacture and distribute superior quality office furniture, which meets or exceeds the requirements of our customers.
- Confirmation that Evolve is committed (1) to providing product that, through their entire life cycle, minimize negative environmental impacts on the environment, (2) to continuous improvement to our environmental systems and programs and (3) to comply to all relevant environmental legislation and regulations.
- Evolve Systems can help a company meet LEED requirements for office furniture.
- Evolve components are tested to the highest standard in the industry. This is your assurance of quality and longevity.

TECHNICAL FEATURES OF POWER BEAM:

- Evolve Power Beam is 2 7/8" thick.
- An aluminum low profile top cap is included with Power Beams.
- Power Beam will accommodate 65 .25" diameter communication cables without electrical or 54 .25" diameter communication cables with electrical.
- 90-degree post extension accommodates 45 .25" diameter communication cables without electrical and 25 .25" diameter communication cables with electric.
- Raceway knockout openings are 1.38" x 2.71".

BASIC FEATURES OF POWER BEAM:

- Power Beam is available in three (3) heights: 24"h, 30"h and 36"h; and seven (7) widths: 36"w, 42"w, 48"w, 54"w, 60"w, 66"w and 72"w.
- There is no panel creep in a straight Beam-to-Beam configuration; however, a corner post (2, 3, 4 way) will add 3.25" inches to a beam run.

BASIC FEATURES OF EXTENSION MODULES:

- Extension modules stack on the top of a Power Beam or another extension module (maximum height - 42"h, above finished floor).
- Fabric extension modules may have different fabrics on opposite sides within the same grade with no up-charge.
- If different grades of fabric are used on one module, the entire modules will be priced utilizing the fabric with the highest grade.

GENERAL WARRANTY INFORMATION:

- Panel and tackboard textiles, adjustable keyboard mechanisms, tasklights and electrical devices = ten (10) Years
- Other parts = Lifetime Warranty

POWER BEAM

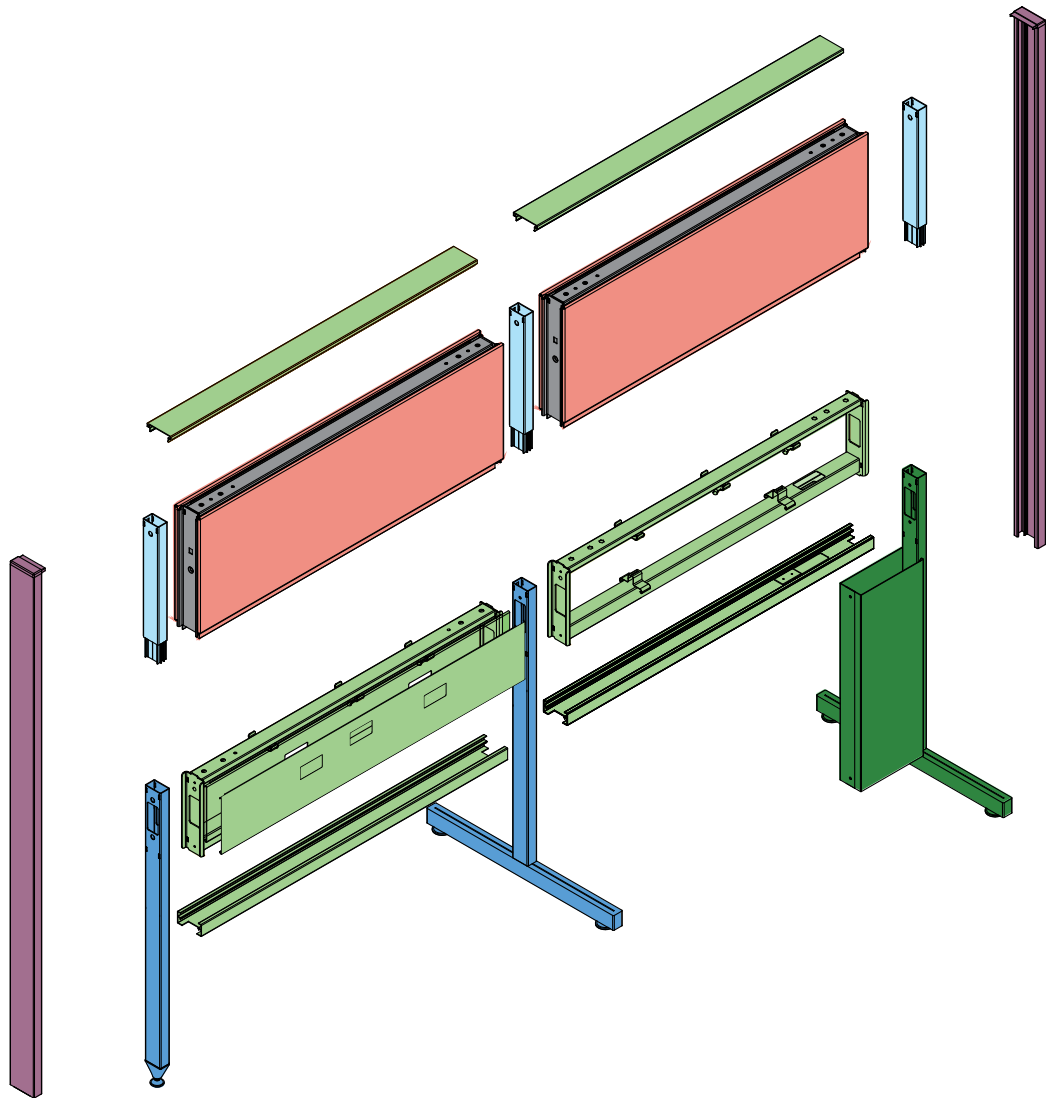

**POWER BEAM
RACEWAY**



**VERTICAL
BASE INFEEED
COVER**



LEGS



**EXTENSION
MODULE
CONNECTOR**



**EXTENSION
MODULE**



**END OF RUN
TRIM**

EXTENSION MODULE MATERIALS

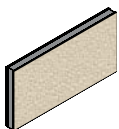

FABRIC

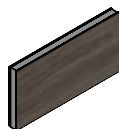

LAMINATE

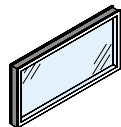

GLASS



WRITE BOARD

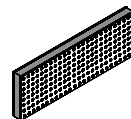

AIRFLOW

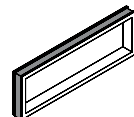

OPEN

POWER BEAM KITS

EVPBE - 6" HIGH POWER BEAM WITH ELECTRICAL CUTOUT FOR BASE INFEED (36"W TO 60"W)

- Power beam with bottom cut out (on one end) for base infeed
- Aluminum top trim and bottom trim included
- Bottom trim has a cut out on one side for electrical access and a bracket to connect to the vertical base infeed cover (ordered separately)
- Vertical base infeed cover with support leg ordered separately
- Power distribution housing to be specified separately

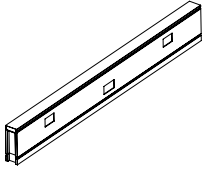
DESCRIPTION	PRODUCT CODE	LIST PRICE LP	DIMENSIONS/INCHES		
			H	W	D
	EVPBE36	292	6	36	2 7/8
	EVPBE42	316	6	42	2 7/8
	EVPBE48	343	6	48	2 7/8
	EVPBE54	450	6	54	2 7/8
	EVPBE60	389	6	60	2 7/8

EVPBE - 6" HIGH POWER BEAM WITH ELECTRICAL CUT OUT FOR BASE INFEED (66"W AND 72"W)

- Power beam with bottom cut out (on one end) for base infeed
- Aluminum top trim and bottom trim included
- Bottom trim has a cut out on one side for electrical access and a bracket to connect to the vertical base infeed cover (ordered separately)
- Vertical base infeed cover with support leg ordered separately
- Power distribution housing to be specified separately

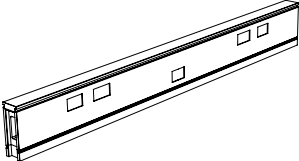
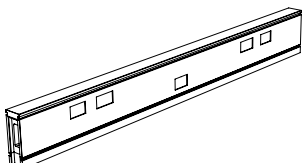
DESCRIPTION	PRODUCT CODE	LIST PRICE LP	DIMENSIONS/INCHES		
			H	W	D
	EVPBE66	624	6	66	2 7/8
	EVPBE72	650	6	72	2 7/8

POWER BEAM KITS

EVPB - 6" HIGH POWER BEAM RACEWAY (36"W TO 60"W)

- Aluminum top trim and bottom trim included
- No access for base infeed
- Support legs ordered separately
- Power distribution housing to be specified separately

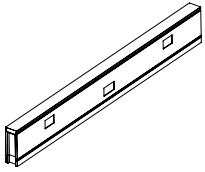
DESCRIPTION	PRODUCT CODE	LIST PRICE LP	DIMENSIONS/INCHES		
			H	W	D
	EVPB36	338	6	36	2 7/8
	EVPB42	359	6	42	2 7/8
	EVPB48	423	6	48	2 7/8
	EVPB54	455	6	54	2 7/8
	EVPB60	493	6	60	2 7/8

EVPB - 6" HIGH POWER BEAM RACEWAY (66"W AND 72"W)

- Power distribution housing to be specified separately
- One piece aluminum top trim and one piece aluminum bottom trim included
- No access for base infeed
- Support legs ordered separately

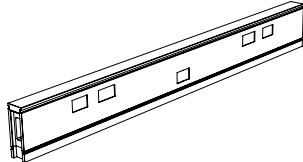
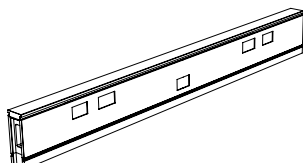
DESCRIPTION	PRODUCT CODE	LIST PRICE LP	DIMENSIONS/INCHES		
			H	W	D
	EVPB66	591	6	66	2 7/8
	EVPB72	614	6	72	2 7/8

EVPBEP - POWER BEAM KIT WITH ELECTRICAL CUT OUT FOR PASS THROUGH CABINET

- Power beam with electrical cut out for base feed from pass through cabinet
- Aluminum top trim included
- 60" Power beam kit includes two 30" power distribution housing (EVE8PD30) and jumper cable (EVE8CP17)
- 72" Power beam kit includes two 36" power distribution housing (EVE8PD36) and jumper cable (EVE8CP17)
- Provides two duplex receptacle per panel side
- Power beam base feed to be ordered separately
- Power Beam Storage cabinet with pass through needs to be ordered separately (EVPBSCGDP or EVPBSCP) See page 34

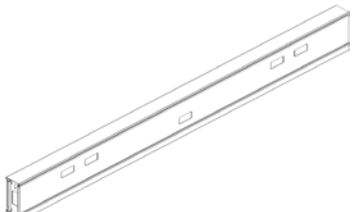
DESCRIPTION	PRODUCT CODE	LIST PRICE LP	DIMENSIONS/INCHES		
			H	W	D
	EVPBEP60KIT	961	6	60	2 7/8
	EVPBEP72KIT	1275	6	72	2 7/8

NOTE: To be used with cable pass through cabinet

POWER BEAM KITS / VERTICAL BASE INFEED COVER W/LEG

EVPBEP - POWER BEAM KIT WITH ELECTRICAL CUT OUT FOR PASS THROUGH CABINET

- Power beam with electrical cut out for base feed from pass through cabinet
- Aluminum top trim included
- 60" Power beam kit includes two 30" raceway covers per side
- 72" Power beam kit includes two 36" raceway covers per side
- 60" Power beam kit includes two 30" power distribution housing (EVE8PD30) and jumper cable (EVE8CP17)
- 72" Power beam kit includes two 36" power distribution housing (EVE8PD36) and jumper cable (EVE8CP17)
- Provides four duplex receptacle per panel side
- Power beam base feed to be ordered separately
- Power Beam Storage cabinet with pass through to be ordered separately (EVPBSCGDP or EVPBSCP)

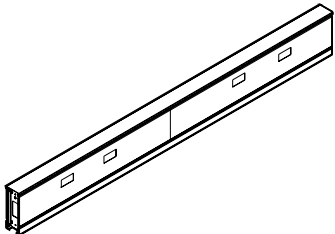
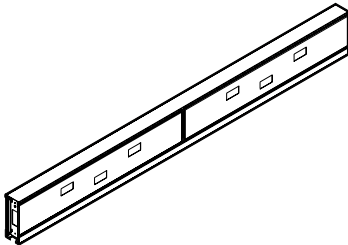
DESCRIPTION	PRODUCT CODE	LIST PRICE LP	DIMENSIONS/INCHES		
			H	W	D
	EVPBEP60KIT01	986	6	60	2 7/8
	EVPBEP72KIT01	1275	6	72	2 7/8

NOTE: To be used with cable pass through cabinet

EVPBFCL - VERTICAL BASE INFEED COVER INCLUDING SUPPORT LEG WITH FOOT

- Connects to Power Beam Kit with electrical cut out
- Includes vertical cover and slotted connector support leg with foot
- Power Beam kit with electrical cut out ordered separately
- Base infeed ordered separately

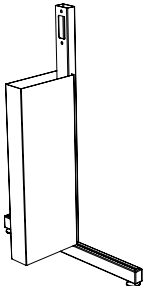
DESCRIPTION	PRODUCT CODE	LIST PRICE LP	DIMENSIONS/INCHES		
			H	W	D
	EVPBFCL24	247	24	6	18
	EVPBFCL30	265	30	6	18
	EVPBFCL36	354	36	6	18

VERTICAL BASE INFEED COVER W/LEG FOR NY POWER BOX ENTRY

EVPBFCSL - VERTICAL BASE POWER FEED COVER WITH SINGLE LEG

- Connects to electrical cut out power beam
- Includes vertical covers and slotted connector with single leg
- For one sided Power beam application
- Laminate end panels must be attached to single leg at end of power beam run for stability
- Laminate end panels to be ordered separately
- End of run trim below power beam included
- Power beam with electrical cut out to be ordered separately

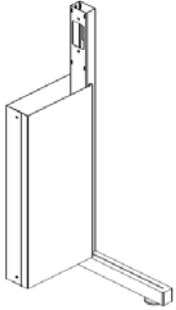

DESCRIPTION	PRODUCT CODE	LIST PRICE LP	DIMENSIONS/INCHES		
			H	W	D
	EVPBFCSL24	247	24	15	
	EVPBFCSL30	266	30	15	
	EVPBFCSL36	290	36	15	

EVPBFBG - VERTICAL BASE INFEED COVER INCLUDING SUPPORT LEG WITH GLIDE

- Connects to Power Beam Kit with electrical cut out
- Includes vertical cover and slotted connector support leg with glide
- Power Beam Kit with electrical cut out ordered separately
- Base infeed ordered separately



DESCRIPTION	PRODUCT CODE	LIST PRICE LP	DIMENSIONS/INCHES		
			H	W	D
	EVPBFCG24	198	24	6	2 7/8
	EVPBFCG30	226	30	6	2 7/8
	EVPBFCG36	254	36	6	2 7/8

EVPBFCLXXNY - VERTICAL COVER WITH LEG FOR NY BOX POWER ENTRY

- Connects to electrical cut out power beam
- Includes vertical covers and slotted connector with leg
- End of run trim below power beam included
- Power Beam with electrical cut out to be ordered separately

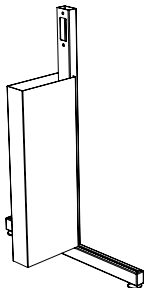

DESCRIPTION	PRODUCT CODE	LIST PRICE LP	DIMENSIONS/INCHES		
			H	W	D
	EVPBFCL24NY	247	24	6	21
	EVPBFCL30NY	265	30	6	21
	EVPBFCL36NY	354	36	6	21

VERTICAL BASE INFEED COVER W/LEG FOR NY POWER BOX ENTRY / SUPPORT LEGS

EVPBFBGXXNY - VERTICAL COVER WITH GLIDE FOR NY BOX POWER ENTRY

- Connects to Power Beam Kit with electrical cut out.
- Includes vertical covers and slotted connector with glide base.
- End of run trim below power beam included.
- Power Beam with electrical cut out to be ordered seperately.



DESCRIPTION	PRODUCT CODE	LIST PRICE LP	DIMENSIONS/INCHES		
			H	W	D
	EVPBFCG24NY	198	24	6	2 7/8
	EVPBFCG30NY	226	30	6	2 7/8
	EVPBFCG36NY	254	36	6	2 7/8

EVPBL - POWER BEAM CONNECTOR SUPPORT LEG WITH FOOT

- Connects two Power Beams in a straight run.
- 24" h -- 18" open to floor
- 30" h -- 24" open to floor
- 36" h -- 30" open to floor

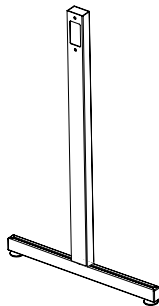

DESCRIPTION	PRODUCT CODE	LIST PRICE LP	DIMENSIONS/INCHES		
			H	W	D
	EVPBL24	117	24	18	
	EVPBL30	122	30	18	
	EVPBL36	161	36	18	

EVPBLFF - POWER BEAM LEG WITH FLAT FOOT

- Connects two Power Beams on equal height.
- Includes connector with flat foot, connecting hardware.
- Note: Leg has to be used next to Post legs with glides. When specifying please keep sequence post leg with glide, leg with flat foot, post leg with glide. Only post legs with glide provides adjustment for leveling power beams run.

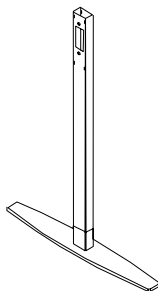

DESCRIPTION	PRODUCT CODE	LIST PRICE LP	DIMENSIONS/INCHES		
			H	W	D
	EVPBLFF24	139	24	21	
	EVPBLFF30	146	30	21	
	EVPBLFF36	156	36	21	

SUPPORT LEGS

EVPBSL - POWER BEAM SINGLE LEG

- Connects two Power Beams in a straight run.
- Includes non slotted connector with leg, glides and connecting hardware
- For one sided Power beam application
- Laminate end panels must be attached to single leg at end of power beam run for stability
- Laminate end panels to be ordered separately

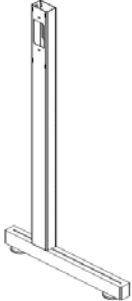
DESCRIPTION	PRODUCT CODE	LIST PRICE LP	DIMENSIONS/INCHES		
			H	W	D
	EVPBSL24	150	24	15	
	EVPBSL30	124	30	15	
	EVPBSL36	129	36	15	

EVPBCB - POWER BEAM CONNECTOR SUPPORT LEG WITH GLIDE

- Connects two Power Beams in a straight run.
- 24'h -- 18" open to floor
- 30"h -- 24" open to floor
- 36"h -- 30" open to floor

DESCRIPTION	PRODUCT CODE	LIST PRICE LP	DIMENSIONS/INCHES		
			H	W	D
	EVPBGICB24	79	24	2	
	EVPBGICB30	86	30	2	
	EVPBGICB36	91	36	2	

EVPB24CPA - ONE WAY POST WITH T LEG FOR 24" H POWER BEAM

- One way post attaches to end of power beam run
- Post and connecting hardware add 3.25" to power beam run
- Includes post, power beam T leg, post with trim all around, levelling glide, hardware and trim kit
- Includes two floor mount plates to secure post to floor

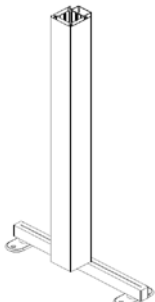
DESCRIPTION	PRODUCT CODE	LIST PRICE LP	DIMENSIONS/INCHES		
			H	W	D
	EVPB24CPA124	365	24	3	2 7/8
	EVPB24CPA130	387	30	3	2 7/8
	EVPB24CPA136	401	36	3	2 7/8
	EVPB24CPA142	454	42	3	2 7/8

SUPPORT LEGS / CORNER POST - 90-DEGREE

EVPB30CPA - ONE WAY POST WITH T LEG FOR 30" H POWER BEAM

- One way post attaches to end of power beam run
- Post and connecting hardware add 3.25" to power beam run
- Includes post, power beam T leg, post with trim all around, levelling glide, hardware and trim kit
- Includes two floor mount plates to secure post to floor

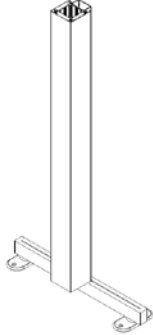
DESCRIPTION	PRODUCT CODE	LIST PRICE LP	DIMENSIONS/INCHES		
			H	W	D
	EVPB30CPA130	387	30	3	2 7/8
	EVPB30CPA136	401	36	3	2 7/8
	EVPB30CPA142	454	42	3	2 7/8

EVPB36CPA - ONE WAY POST WITH T LEG FOR 36" H POWER BEAM

- One way post attaches to end of power beam run
- Post and connecting hardware add 3.25" to power beam run
- Includes post, power beam T leg, post with trim all around, levelling glide, hardware and trim kit
- Includes two floor mount plates to secure post to floor

DESCRIPTION	PRODUCT CODE	LIST PRICE LP	DIMENSIONS/INCHES		
			H	W	D
	EVPB36CPA136	401	36	3	2 7/8
	EVPB36CPA142	454	42	3	2 7/8

EVPBCEPLA - POWER BEAM 2 WAY CORNER POST

- Connects two power beams of equal height in 90 degree configuration
- Post and connecting hardware add 3.25" to power beam run
- Includes one post, two nonslotted power beam connectors, post with trim all around, levelling glide, hardware and trim kit

DESCRIPTION	PRODUCT CODE	LIST PRICE	DIMENSIONS/INCHES		
			H	W	D
	EVPBCEPLA224	188	24	3	3
	EVPBCEPLA230	194	30	3	3
	EVPBCEPLA236	204	36	3	3

CORNER POST - 90-DEGREE

EVPBCEPLA - POWER BEAM 3 WAY CORNER POST

- Connects three power beams of equal height in 90 degree configuration
- Post and connecting hardware add 3.25" to power beam run
- Includes one post, three nonslotted power beam connectors, post with trim all around, levelling glide, hardware and trim kit

DESCRIPTION	PRODUCT CODE	LIST PRICE	DIMENSIONS/INCHES		
			H	W	D
	EVPBCEPLA324	206	24	3	3
	EVPBCEPLA330	214	30	3	3
	EVPBCEPLA336	224	36	3	3

EVPBCEPLA - POWER BEAM 4 WAY CORNER POST

- Includes one post, four nonslotted power beam connectors, post with trim all around, levelling glide, hardware and trim kit
- Connects four power beams of equal height in 90 degree configuration
- Post and connecting hardware add 3.25" to power beam run

DESCRIPTION	PRODUCT CODE	LIST PRICE	DIMENSIONS/INCHES		
			H	W	D
	EVPBCEPLA424	246	24	3	3
	EVPBCEPLA430	264	30	3	3
	EVPBCEPLA436	270	36	3	3

EVPBCIPLA - POWER BEAM INLINE 2 WAY CORNER POST

- Connects two power beams of equal height in inline configuration
- Post and connecting hardware add 3.25" to power beam run
- Includes one post, two nonslotted power beam connectors, post with trim all around, levelling glide, hardware and trim kit

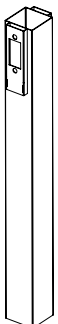
DESCRIPTION	PRODUCT CODE	LIST PRICE	DIMENSIONS/INCHES		
			H	W	D
	EVPBCIPLA224	188	24	3	3
	EVPBCIPLA230	194	30	3	3
	EVPBCIPLA236	204	36	3	3

CORNER POST - 90-DEGREE

EVPB24CPA - PANEL TO 24" H POWER BEAM 2 WAY CORNER POST

- Connects one panel and one 24" H power beam in 90 degree configuration
- Includes post, panel connectors and power beam connectors, post with trim all around, levelling glide, hardware and trim kit
- Post and connecting hardware add 3.25" to power beam run
- Pass thru only for power beam

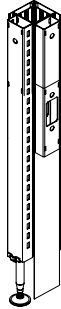

DESCRIPTION	PRODUCT CODE	LIST PRICE	DIMENSIONS/INCHES		
			H	W	D
	EVPB24CPA230	191	30	3	3
	EVPB24CPA236	235	36	3	3
	EVPB24CPA242	235	42	3	3
	EVPB24CPA230R	191	30	3	3
	EVPB24CPA236R	235	36	3	3
	EVPB24CPA242R	235	42	3	3

EVPB30CPA - PANEL TO 30" H POWER BEAM 2 WAY CORNER POST

- Connects one panel and one 30" H power beam in 90 degree configuration
- Includes post, panel connectors and power beam connectors, post with trim all around, levelling glide, hardware and trim kit
- Post and connecting hardware add 3.25" to power beam run
- Pass thru only for power beam

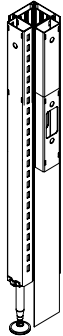

DESCRIPTION	PRODUCT CODE	LIST PRICE	DIMENSIONS/INCHES		
			H	W	D
	EVPB30CPA230	191	30	3	3
	EVPB30CPA236	235	36	3	3
	EVPB30CPA242	235	42	3	3
	EVPB30CPA230R	191	30	3	3
	EVPB30CPA236R	235	36	3	3
	EVPB30CPA242R	235	42	3	3

EVPB36CPA - PANEL TO 36" H POWER BEAM 2 WAY CORNER POST

- Connects one panel and one 36" H power beam in 90 degree configuration
- Includes post, panel connectors and power beam connectors, post with trim all around, levelling glide, hardware and trim kit
- Post and connecting hardware add 3.25" to power beam run
- Pass thru only for power beam

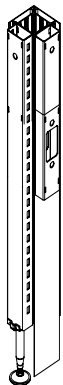

DESCRIPTION	PRODUCT CODE	LIST PRICE	DIMENSIONS/INCHES		
			H	W	D
	EVPB36CPA236	235	36	3	3
	EVPB36CPA242	235	42	3	3
	EVPB36CPA236R	235	36	3	3
	EVPB36CPA242R	235	42	3	3

CORNER POST - 90-DEGREE

EVPB24CPA - PANEL TO 24" H POWER BEAM 3 WAY CORNER POST

- Connects two panels and one 24" H power beam in 90 degree configuration
- Includes post, panel connectors and power beam connectors, post with trim all around, levelling glide, hardware and trim kit
- Post and connecting hardware add 3.25" to power beam run
- Pass thru only for power beam

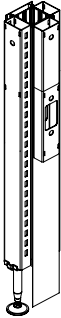
DESCRIPTION	PRODUCT CODE	LIST PRICE LP	DIMENSIONS/INCHES		
			H	W	D
	EVPB24CPA330	234	30	3	3
	EVPB24CPA336	303	36	3	3
	EVPB24CPA342	303	42	3	3

EVPB30CPA - PANEL TO 30" H POWER BEAM 3 WAY CORNER POST

- Connects two panels and one 30" H power beam in T degree configuration
- Includes post, panel connectors and power beam connectors, post with trim all around, levelling glide, hardware and trim kit
- Post and connecting hardware add 3.25" to power beam run
- Pass thru only for power beam

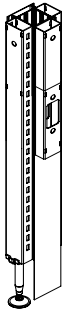
DESCRIPTION	PRODUCT CODE	LIST PRICE	DIMENSIONS/INCHES		
			H	W	D
	EVPB30CPA330	234	30	3	3
	EVPB30CPA336	312	36	3	3
	EVPB30CPA342	312	42	3	3

EVPB36CPA - PANEL TO 36" H POWER BEAM 3 WAY CORNER POST

- Connects two panels and one 36" H power beams in T degree configuration
- Includes post, panel connectors and power beam connectors, post with trim all around, levelling glide, hardware and trim kit
- Post and connecting hardware add 3.25" to power beam run
- Pass thru only for power beam

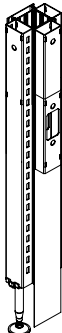
DESCRIPTION	PRODUCT CODE	LIST PRICE	DIMENSIONS/INCHES		
			H	W	D
	EVPB36CPA336	312	36	3	3
	EVPB36CPA342	312	42	3	3

CORNER POST - 90-DEGREE

EVPB24CPA - PANEL TO 24" H POWER BEAM 3 WAY CORNER POST

- Connects two 24" H power beams with panel in T configuration
- Includes post, panel connectors and power beam connectors, post with trim all around, levelling glide, hardware and trim kit
- Post and connecting hardware add 3.25" to power beam run
- Pass thru only for power beam

DESCRIPTION	PRODUCT CODE	LIST PRICE LP	DIMENSIONS/INCHES		
			H	W	D
	EVPB24CPA330P	234	30	3	3
	EVPB24CPA336P	312	36	3	3
	EVPB24CPA342P	312	42	3	3

EVPB30CPA - PANEL TO 30" H POWER BEAM 3 WAY CORNER POST

- Connects two 30" H power beams with panel in T configuration
- Includes post, panel connectors and power beam connectors, post with trim all around, levelling glide, hardware and trim kit
- Post and connecting hardware add 3.25" to power beam run
- Pass thru only for power beam

DESCRIPTION	PRODUCT CODE	LIST PRICE	DIMENSIONS/INCHES		
			H	W	D
	EVPB30CPA330P	234	30	3	3
	EVPB30CPA336P	312	36	3	3
	EVPB30CPA342P	312	42	3	3

EVPB36CPA - PANEL TO 36" H POWER BEAM 3 WAY CORNER POST

- Connects one panels and two 36" H power beams in T configuration
- Includes post, panel connectors and power beam connectors, post with trim all around, levelling glide, hardware and trim kit
- Post and connecting hardware add 3.25" to power beam run
- Pass thru only for power beam

DESCRIPTION	PRODUCT CODE	LIST PRICE	DIMENSIONS/INCHES		
			H	W	D
	EVPB36CPA336P	312	24	3	3
	EVPB36CPA342P	312	30	3	3

CORNER POST - 90-DEGREE

EVPB24CPA - PANEL TO 24" H POWER BEAM 4 WAY CORNER POST

- Connects two panels and two 24" H power beams in X configuration
- Includes post, panel connectors and power beam connectors, post with trim all around, levelling glide, hardware and trim kit
- Post and connecting hardware add 3.25" to power beam run
- Pass thru only for power beam

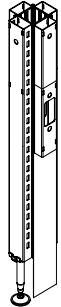
DESCRIPTION	PRODUCT CODE	LIST PRICE LP	DIMENSIONS/INCHES		
			H	W	D
	EVPB24CPA430	287	30	3	3
	EVPB24CPA436	365	36	3	3
	EVPB24CPA442	365	42	3	3

EVPB30CPA - PANEL TO 30" H POWER BEAM 4 WAY CORNER POST

- Connects two panels and two 30" H power beams in X configuration
- Includes post, panel connectors and power beam connectors, post with trim all around, levelling glide, hardware and trim kit
- Post and connecting hardware add 3.25" to power beam run
- Pass thru only for power beam

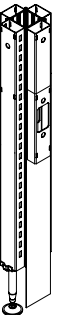
DESCRIPTION	PRODUCT CODE	LIST PRICE	DIMENSIONS/INCHES		
			H	W	D
	EVPB30CPA430	287	30	3	3
	EVPB30CPA436	365	36	3	3
	EVPB30CPA442	365	42	3	3

EVPB36CPA - PANEL TO 36" H POWER BEAM 4 WAY CORNER POST

- Connects two panels and two 36" H power beams in X configuration
- Includes post, panel connectors and power beam connectors, post with trim all around, levelling glide, hardware and trim kit
- Post and connecting hardware add 3.25" to power beam run
- Pass thru only for power beam

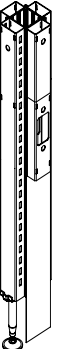
DESCRIPTION	PRODUCT CODE	LIST PRICE	DIMENSIONS/INCHES		
			H	W	D
	EVPB36CPA436	365	24	3	3
	EVPB36CPA442	365	30	3	3

CORNER POST - 120-DEGREE

EVPB6CEPLA - POWER BEAM 2-WAY 120-DEGREE CORNER POST

- Connects two power beams of equal height in 120 degree configuration
- Includes one post, two nonslotted power beam connectors, post with trim all around, levelling glide, hardware and trim kit

DESCRIPTION	PRODUCT CODE	LIST PRICE	DIMENSIONS/INCHES		
			H	W	D
	EVPB6CEPLA224	218	24	3	3
	EVPB6CEPLA230	224	30	3	3
	EVPB6CEPLA236	235	36	3	3

EVPB6CEPLA - POWER BEAM 3-WAY 120-DEGREE CORNER POST

- Connects three power beams of equal height in 120 degree configuration
- Includes one post, three nonslotted power beam connectors, post with trim all around, levelling glide, hardware and trim kit

DESCRIPTION	PRODUCT CODE	LIST PRICE	DIMENSIONS/INCHES		
			H	W	D
	EVPB6CEPLA324	236	24	3	3
	EVPB6CEPLA330	243	30	3	3
	EVPB6CEPLA336	254	36	3	3

EXTENSION CONNECTORS / POSTS

EVPBIEC - EXTENSION CONNECTOR FOR POWER BEAM

- Attaches to power beam connector
- Includes non slotted extension connector and connecting hardware
- Must be attached to power beam connector with provided screw before installing power beam

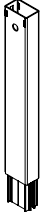
DESCRIPTION	PRODUCT CODE	LIST PRICE	DIMENSIONS/INCHES		
			H	W	D
	EVPBIEC06	53	6	2 7/8	
	EVPBIEC12	52	12	2 7/8	
	EVPBIEC18	61	18	2 7/8	
	EVPBIEC24	63	24	2 7/8	

EVPBCEPA1 - POWER BEAM CORNER EXTENSION POST 1 WAY

- Connects at end of a run of extension modules
- Post and connecting hardware add 3.25" to power beam run
- Includes one extension post, one non slotted extension connectors for power beam, connecting hardware and trim kit
- Power Beam Corner Extension Post are not stackable

DESCRIPTION	PRODUCT CODE	LIST PRICE	DIMENSIONS/INCHES		
			H	W	D
	EVPBCEPA106	97	6	3	3
	EVPBCEPA112	97	12	3	3
	EVPBCEPA118	122	18	3	3
	EVPBCEPA124	122	24	3	3

EVPBCEIPA2 - POWER BEAM INLINE 2 WAY CORNER EXTENSION POST

- Connects two extension modules in inline configuration
- Post and connecting hardware add 3.25" to power beam run
- Includes one extension post, two non slotted extension connectors for power beam, connecting hardware and trim kit
- Power Beam Corner Extension Post are not stackable

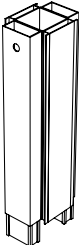
DESCRIPTION	PRODUCT CODE	LIST PRICE	DIMENSIONS/INCHES		
			H	W	D
	EVPBCEIPA206	104	6	3	3
	EVPBCEIPA212	104	12	3	3
	EVPBCEIPA218	170	18	3	3
	EVPBCEIPA224	170	24	3	3

CORNER EXTENSION POST - 90 - DEGREE

EVPBCEPA2 - POWER BEAM CORNER EXTENSION POST 2 WAY

- Connects two extension modules in 90 degree configuration
- Post and connecting hardware add 3.25" to power beam run
- Includes one extension post, two non slotted extension connectors for power beam , connecting hardware and trim kit
- Power Beam Corner Extension Post are not stackable

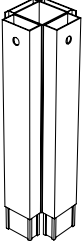
DESCRIPTION	PRODUCT CODE	LIST PRICE	DIMENSIONS/INCHES		
			H	W	D
	EVPBCEPA206	99	6	3	3
	EVPBCEPA212	99	12	3	3
	EVPBCEPA218	156	18	3	3
	EVPBCEPA224	156	24	3	3

EVPBCEPA3 - POWER BEAM CORNER EXTENSION POST 3 WAY

- Connects three extension modules in 90 degree configuration
- Post and connecting hardware add 3.25" to power beam run
- Includes one extension post, three non slotted extension connectors for power beam , connecting hardware and trim kit
- Power Beam Corner Extension Post are not stackable

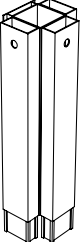
DESCRIPTION	PRODUCT CODE	LIST PRICE	DIMENSIONS/INCHES		
			H	W	D
	EVPBCEPA306	118	6	3	3
	EVPBCEPA312	118	12	3	3
	EVPBCEPA318	182	18	3	3
	EVPBCEPA324	182	24	3	3

EVPBCEP4 - POWER BEAM CORNER EXTENSION POST 4 WAY

- Connects four extension modules in 90 degree configuration
- Post and connecting hardware add 3.25" to power beam run
- Includes one extension post, four non slotted extension connectors for power beam connecting hardware and trim kit
- Power Beam Corner Extension Post are not stackable

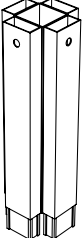
DESCRIPTION	PRODUCT CODE	LIST PRICE	DIMENSIONS/INCHES		
			H	W	D
	EVPBCEP406	136	6	3	3
	EVPBCEP412	136	12	3	3
	EVPBCEP418	201	18	3	3
	EVPBCEP424	201	24	3	3

CORNER EXTENSION POST - 120 - DEGREE

EVPB6CEPA1 - POWER BEAM 120 DEGREE CORNER EXTENSION POST 1 WAY

- Connects one extension module in 120 degree configuration
- Includes one extension post, three non slotted extension connectors for power beam , connecting hardware and trim kit
- Power Beam Corner Extension Post are not stackable

DESCRIPTION	PRODUCT CODE	LIST PRICE	DIMENSIONS/INCHES		
			H	W	D
	EVPB6CEPA124	159	24	3	3

EVPB6CEPA2 - POWER BEAM 120-DEGREE CORNER EXTENSION POST 2 WAY

- Connects two extension modules in 120 degree configuration
- Includes one extension post, two non slotted extension connectors for power beam , connecting hardware and trim kit
- Power Beam Corner Extension Post are not stackable

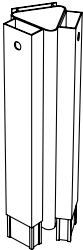
DESCRIPTION	PRODUCT CODE	LIST PRICE	DIMENSIONS/INCHES		
			H	W	D
	EVPB6CEPA206	99	6	3	3
	EVPB6CEPA212	99	12	3	3
	EVPB6CEPA218	152	18	3	3
	EVPB6CEPA224	152	24	3	3

EVPB6CEP3 - POWER BEAM 120 DEGREE CORNER EXTENSION POST 3 WAY

- Connects three extension modules in 120 degree configuration
- Includes one extension post, three non slotted extension connectors for power beam , connecting hardware and trim kit
- Power Beam Corner Extension Post are not stackable

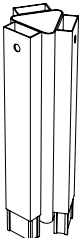
DESCRIPTION	PRODUCT CODE	LIST PRICE	DIMENSIONS/INCHES		
			H	W	D
	EVPB6CEP306	117	6	3	3
	EVPB6CEP312	117	12	3	3
	EVPB6CEP318	182	18	3	3
	EVPB6CEP324	182	24	3	3

POWER BEAM FLX

EVPB24CPSANR - NR PANEL TO 24"H POWER BEAM 4 WAY CORNER POST

- Connects two NR panels and two 24"H power beams in 90 degree configuration
- Post and connecting hardware ad 3.25" to power beam run
- Includes post, panel connectors and power beam connectors, post with trim all around, levelling glide, hardware and trim kit. Pass through only for power beam, power beam leg slotted

DESCRIPTION	PRODUCT CODE	LIST PRICE	DIMENSIONS/INCHES		
			H	W	D
	EVPB24CPSA430NR	286	30	3	3
	EVPB24CPSA436NR	365	36	3	3
	EVPB24CPSA442NR	365	42	3	3

EVPB30CPSANR - NR PANEL TO 30"H POWER BEAM 4 WAY CORNER POST

- Connects two NR panels and two 30"H power beams in 90 degree configuration
- Post and connecting hardware ad 3.25" to power beam run
- Includes post, panel connectors and power beam connectors, post with trim all around, levelling glide, hardware and trim kit. Pass through only for power beam, power beam leg slotted

DESCRIPTION	PRODUCT CODE	LIST PRICE	DIMENSIONS/INCHES		
			H	W	D
	EVPB30CPSA430NR	286	30	3	3
	EVPB30CPSA436NR	365	36	3	3
	EVPB30CPSA442NR	365	42	3	3

EVPB36CPSANR - NR PANEL TO 36"H POWER BEAM 4 WAY CORNER POST

- Connects two NR panels and two 36"H power beams in 90 degree configuration
- Post and connecting hardware ad 3.25" to power beam run
- Includes post, panel connectors and power beam connectors, post with trim all around, levelling glide, hardware and trim kit. Pass through only for power beam, power beam leg slotted

DESCRIPTION	PRODUCT CODE	LIST PRICE	DIMENSIONS/INCHES		
			H	W	D
	EVPB36CPSA436NR	365	36	3	3
	EVPB36CPSA442NR	365	42	3	3

POWER BEAM FLX

EVPB24CPSANR - NR PANEL TO 24"H POWER BEAM 3 WAY CORNER POST

- Connects NR panels and 24"H power beams in 90 degree configuration
- Post and connecting hardware ad 3.25" to power beam run
- Includes post, panel connectors and power beam connectors, post with trim all around, levelling glide, hardware and trim kit. Pass through only for power beam, power beam leg slotted

DESCRIPTION	PRODUCT CODE	LIST PRICE	DIMENSIONS/INCHES		
			H	W	D
	EVPB24CPSA330NR	233	30	3	3
	EVPB24CPSA336NR	311	36	3	3
	EVPB24CPSA342NR	311	42	3	3

EVPB30CPSANR - NR PANEL TO 30"H POWER BEAM 3 WAY CORNER POST

- Connects NR panels and 30"H power beams in 90 degree configuration
- Post and connecting hardware ad 3.25" to power beam run
- Includes post, panel connectors and power beam connectors, post with trim all around, levelling glide, hardware and trim kit. Pass through only for power beam, power beam leg slotted

DESCRIPTION	PRODUCT CODE	LIST PRICE	DIMENSIONS/INCHES		
			H	W	D
	EVPB30CPSA330NR	233	30	3	3
	EVPB30CPSA336NR	311	36	3	3
	EVPB30CPSA342NR	311	42	3	3

EVPB36CPSANR - NR PANEL TO 36"H POWER BEAM 3 WAY CORNER POST

- Connects NR panels and 36"H power beams in 90 degree configuration
- Post and connecting hardware ad 3.25" to power beam run
- Includes post, panel connectors and power beam connectors, post with trim all around, levelling glide, hardware and trim kit. Pass through only for power beam, power beam leg slotted

DESCRIPTION	PRODUCT CODE	LIST PRICE	DIMENSIONS/INCHES		
			H	W	D
	EVPB36CPSA336NR	311	36	3	3
	EVPB36CPSA342NR	311	42	3	3

POWER BEAM FLX

EVPB24CPSANR - NR PANEL TO 24"H POWER BEAM 2 WAY CORNER POST

- Connects one NR panel and one 24"H power beam in 90 degree configuration
- Post and connecting hardware ad 3.25" to power beam run
- Includes post, panel connectors and power beam connectors, post with trim all around, levelling glide, hardware and trim kit. Pass through only for power beam, power beam leg slotted

DESCRIPTION	PRODUCT CODE	LIST PRICE	DIMENSIONS/INCHES		
			H	W	D
	EVPB24CPSA230NR	188	30	3	3
	EVPB24CPSA236NR	234	36	3	3
	EVPB24CPSA242NR	234	42	3	3

EVPB24CPSANR - NR PANEL TO 30"H POWER BEAM 2 WAY CORNER POST

- Connects one NR panel and one 30"H power beam in 90 degree configuration
- Post and connecting hardware ad 3.25" to power beam run
- Includes post, panel connectors and power beam connectors, post with trim all around, levelling glide, hardware and trim kit. Pass through only for power beam, power beam leg slotted

DESCRIPTION	PRODUCT CODE	LIST PRICE	DIMENSIONS/INCHES		
			H	W	D
	EVPB30CPSA230NR	188	30	3	3
	EVPB30CPSA236NR	234	36	3	3
	EVPB30CPSA242NR	234	42	3	3

EVPB24CPSANR - NR PANEL TO 36"H POWER BEAM 2 WAY CORNER POST

- Connects one NR panel and one 36"H power beam in 90 degree configuration
- Post and connecting hardware ad 3.25" to power beam run
- Includes post, panel connectors and power beam connectors, post with trim all around, levelling glide, hardware and trim kit. Pass through only for power beam, power beam leg slotted

DESCRIPTION	PRODUCT CODE	LIST PRICE	DIMENSIONS/INCHES		
			H	W	D
	EVPB36CPSA236NR	234	30	3	3
	EVPB36CPSA242NR	234	36	3	3

POWER BEAM FLX

EVPB24CPSANR - NR PANEL TO 24"H POWER BEAM 3 WAY CORNER POST

- Connects two 24"H power beams with NR panel in "T" configuration
- Post and connecting hardware ad 3.25" to power beam run
- Includes post, panel connectors and power beam connectors, post with trim all around, levelling glide, hardware and trim kit. Pass through only for power beam, power beam leg slotted

DESCRIPTION	PRODUCT CODE	LIST PRICE	DIMENSIONS/INCHES		
			H	W	D
	EVPB24CPSA330PNR	233	30	3	3
	EVPB24CPSA336PNR	311	36	3	3
	EVPB24CPSA342PNR	311	42	3	3

EVPB30CPSANR - NR PANEL TO 30"H POWER BEAM 3 WAY CORNER POST

- Connects two 30"H power beams with NR panel in "T" configuration
- Post and connecting hardware ad 3.25" to power beam run
- Includes post, panel connectors and power beam connectors, post with trim all around, levelling glide, hardware and trim kit. Pass through only for power beam, power beam leg slotted

DESCRIPTION	PRODUCT CODE	LIST PRICE	DIMENSIONS/INCHES		
			H	W	D
	EVPB30CPSA330PNR	233	30	3	3
	EVPB30CPSA336PNR	311	36	3	3
	EVPB30CPSA342PNR	311	42	3	3

EVPB36CPSANR - NR PANEL TO 36"H POWER BEAM 3 WAY CORNER POST

- Connects two 36"H power beams with NR panel in "T" configuration
- Post and connecting hardware ad 3.25" to power beam run
- Includes post, panel connectors and power beam connectors, post with trim all around, levelling glide, hardware and trim kit. Pass through only for power beam, power beam leg slotted

DESCRIPTION	PRODUCT CODE	LIST PRICE	DIMENSIONS/INCHES		
			H	W	D
	EVPB36CPSA336PNR	311	36	3	3
	EVPB36CPSA342PNR	311	42	3	3

POWER BEAM FLX

EVPBGICBS - POWER BEAM SLOTTED CONNECTOR WITH BASE FOR GLIDE

- Slotted connector allows to attached brackets for worksurfaces
- Connects two power beams on equal height
- Includes slotted connector with glide and connecting hardware

DESCRIPTION	PRODUCT CODE	LIST PRICE	DIMENSIONS/INCHES		
			H	W	D
	EVPBGICBS24	76	24	2	
	EVPBGICBS30	83	30	2	
	EVPBGICBS36	90	36	2	

Note: Power Beam to be installed in stable configuration using two way posts, three way posts, four way posts to provide support for worksurfaces.

EVPBLS - POWER BEAM SLOTTED CONNECTOR WITH LEG

- Slotted connector allows to attached brackets for worksurfaces
- Connects two power beams on equal height
- Includes slotted connector with leg, glides and connecting hardware

DESCRIPTION	PRODUCT CODE	LIST PRICE	DIMENSIONS/INCHES		
			H	W	D
	EVPBLS24	116	24	18	
	EVPBLS30	122	30	18	
	EVPBLS36	128	36	18	

Note: Power Beam to be installed in stable configuration using two way posts, three way posts, four way posts to provide support for worksurfaces.

EVPBFCGS - VERTICAL BASE POWER FEED COVER WITH GLIDE

- Slotted connector allows to attached brackets for worksurfaces
- Connects to electrical cut out power beam
- Includes vertical covers and slotted connector with glide base, end-of-run trim below power beam. Power Beam with electrical cut out to be ordered separately.

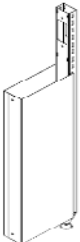
DESCRIPTION	PRODUCT CODE	LIST PRICE	DIMENSIONS/INCHES		
			H	W	D
	EVPBFCGS24	198	24	6	3
	EVPBFCGS30	224	30	6	3
	EVPBFCGS36	255	36	6	3

Note: Power Beam to be installed in stable configuration using two way posts, three way posts, four way posts to provide support for worksurfaces.

POWER BEAM FLX

EVPBFCLS - VERTICAL BASE POWER FEED COVER WITH SLOTTED LEG

- Slotted connector allows to attached brackets for worksurfaces
- Connects to electrical cut out power beam
- Includes vertical covers and slotted connector with leg, end-of-run trim below power beam. Power Beam with electrical cut out to be ordered separately

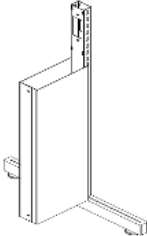
DESCRIPTION	PRODUCT CODE	LIST PRICE	DIMENSIONS/INCHES		
			H	W	D
	EVPBFCLS24	235	24	6	21
	EVPBFCLS30	264	30	6	21
	EVPBFCLS36	290	36	6	21

Note: Power Beam to be installed in stable configuration using two way posts, three way posts, four way posts to provide support for worksurfaces.

EVPBIEC - EXTENSION CONNECTOR SLOTTED FOR POWER

- Attaches to power beam connector
- Includes slotted extension connector and connecting hardware
- Must be attached to power beam connector with provided screw before installing power beam

DESCRIPTION	PRODUCT CODE	LIST PRICE	DIMENSIONS/INCHES		
			H	W	D
	EVPBIECS06	53	6	2.875	
	EVPBIECS12	53	12	2.875	
	EVPBIECS18	63	18	2.875	
	EVPBIECS24	63	24	2.875	

EVPBLERT - END OF RUN TRIM FOR CONNECTOR

- Finishes exposed connector at the end of a run of Power Beam
- Power Beam connector nor included

DESCRIPTION	PRODUCT CODE	LIST PRICE	DIMENSIONS/INCHES		
			H	W	D
	EVPBLERT48	91	45.4	2.875	
	EVPBLERT54	97	51.4	2.875	
	EVPBLERT66	102	63.4	2.875	

Note: Power Beam to be installed in stable configuration using two way posts, three way posts, four way posts to provide support for worksurfaces.

POWER BEAM MOBILE

EVPBGICBM - POWER BEAM CONNECTOR WITH BASE AND CASTOR

- Connects two power beams on equal height
- Includes connector with castor and connecting hardware
- Castors are lockable
- Laminate end panel with castors must be used at end with T leg for stability

DESCRIPTION	PRODUCT CODE	LIST PRICE	DIMENSIONS/INCHES		
			H	W	D
	EVPBGICB24M	95	25	2	
	EVPBGICB30M	102	31	2	
	EVPBGICB36M	109	37	2	

Note: Castors to be locked when power feed is connected to wall outlet. Disconnect power feed from power before moving power beam.

EVPBLM - POWER BEAM CONNECTOR WITH LEG AND CASTORS

- Connects two power beams on equal height
- Includes connector with leg, castors and connecting hardware
- Castors are lockable
- Laminate end panel with castors must be used at end for stability

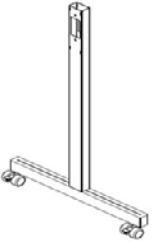
DESCRIPTION	PRODUCT CODE	LIST PRICE	DIMENSIONS/INCHES		
			H	W	D
	EVPBL24M	152	25	18	
	EVPBL30M	158	31	18	
	EVPBL36M	163	37	18	

Note: Castors to be locked when power feed is connected to wall outlet. Disconnect power feed from power before moving power beam.

EVPBFCGM - VERTICAL BASE POWER FEED COVER WITH CASTOR

- Connects to electrical cut out power beam
- Includes vertical covers and connector with castor
- Castors are lockable
- End of run trim below power beam included
- Power beam with electrical cut out to be ordered separately
- Power beam base feed with plug to be used, to be ordered separately
- Laminate end panel with castors must be used at end with T leg for stability

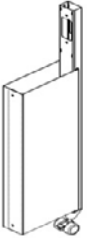
DESCRIPTION	PRODUCT CODE	LIST PRICE	DIMENSIONS/INCHES		
			H	W	D
	EVPBFCG24M	216	25	6	3
	EVPBFCG30M	243	31	6	3
	EVPBFCG36M	273	37	6	3

Note: Castors to be locked when power feed is connected to wall outlet. Disconnect power feed from power before moving power beam.

POWER BEAM MOBILE

EVPBFCLM - VERTICAL BASE POWER FEED COVER WITH LEG AND CASTORS

- Connects to electrical cut out power beam
- Includes vertical covers and connector with leg with castors
- Castors are lockable
- End of run trim below power beam included
- Power beam with electrical cut out to be ordered separately
- Power beam base feed with plug to be used, to be ordered separately
- Laminate end panel with castors must be used at end with T leg for stability

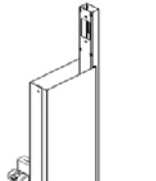
DESCRIPTION	PRODUCT CODE	LIST PRICE	DIMENSIONS/INCHES		
			H	W	D
	EVPBFCL24M	273	25	6	21
	EVPBFCL30M	299	31	6	21
	EVPBFCL36M	328	37	6	21

Note: Castors to be locked when power feed is connected to wall outlet. Disconnect power feed from power before moving power beam.

EVPBLEPM - POWER BEAM LAMINATE END PANEL WITH CASTORS

- Attaches to power beam connector with leg
- Includes brackets to attached to leg
- Finished in thermally fused laminate, if wood grain is selected, grain runs horizontally
- Laminate End Panel height is inclusive of castors

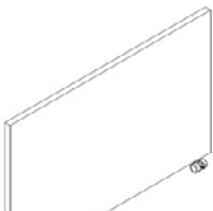
DESCRIPTION	PRODUCT CODE	LIST PRICE	DIMENSIONS/INCHES		
			H	W	D
	EVPBLEP2451M	447	25	51	1
	EVPBLEP3051M	548	31	51	1
	EVPBLEP3651M	656	37	51	1
	EVPBLEP4251M	907	43	51	1
	EVPBLEP2463M	537	25	63	1
	EVPBLEP3063M	660	31	63	1
	EVPBLEP3663M	779	37	63	1
	EVPBLEP4263M	1048	43	63	1

Note: Castors to be locked when power feed is connected to wall outlet. Disconnect power feed from power before moving power beam.

EVE8FR3PBP - POWER ENTRY FOR POWER BEAM WITH PLUG FOR WALL PLATE INFEEED

- Snaps in to power distribution housing
- Includes 48" long flexible vinyl conduit with Dekko plug
- Includes bracket to attach to Vertical raceway panel
- Power beam with electrical cut out must be ordered
- 71" long base feed will work with 24" and 36" H Power beam
- Power beam base feed with Dekko plug will fit only into wall plate infeed
- Wall plate infeed must be hardwired to source by licensed electrician

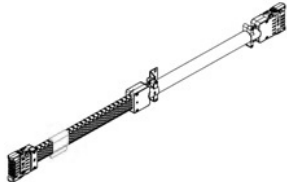
DESCRIPTION	PRODUCT CODE	LIST PRICE	DIMENSIONS/INCHES		
			H	W	D
	EVE8FR3PBP	369		71	

Note: Only compatible with wall plate infeed EVE8WPIPB

POWER BEAM MOBILE

EVE8WPIPB - WALL PLATE INFEEED FOR POWER BEAM WITH DEKKO PLUG

- Wall plate infeed must be installed and hardwired to source by licensed electrician
- Only Power beam base feed with Dekko plug will fit into Wall plate infeed
- Power beam base feed with Dekko plug to be ordered separately

DESCRIPTION	PRODUCT CODE	LIST PRICE	DIMENSIONS/INCHES		
			H	W	D

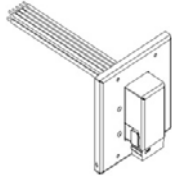

EVE8WPIPB	600	5.25	5.25	1.75
-----------	-----	------	------	------

Note: Only compatible with power beam base feed with Dekko plug EVE8FR3PBP

EVE8CP-H - CEILING PASS THRU CABLES WITH WIRE MESH

- Pass thru cable to connect from ceiling to power beam
- Pass thru cables with wire mesh allows to connect thru ceiling post to Panels, Beltline and Power beam
- In ceiling connects thru "I" connector to hardwired standard ceiling feed laying in ceiling
- "I" connector and standard ceiling feed to be ordered separately

DESCRIPTION	PRODUCT CODE	LIST PRICE	DIMENSIONS/INCHES		
			H	W	D

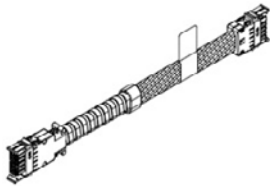

EVE8CP120-H	360	120
EVE8CP180-H	478	180
EVE8CP240-H	593	240

Note: Only compatible with wall plate infeed EVE8WPIPB

EXTENSION MODULES

EXTENSION MODULES BY MATERIALS

Fabric Panel Extension Module

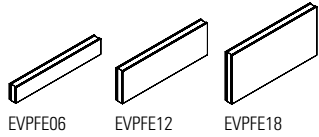

Tempered Glass Panel Extension Module

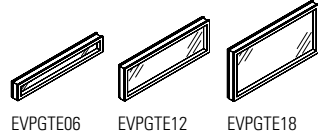

Write Board Extension Module - Single Sided



Write Board Extension Module - Double Sided



Laminate Extension Module - Single Sided

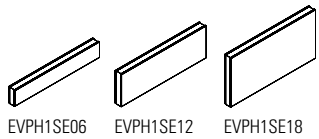

Laminate Extension Module - Double Sided

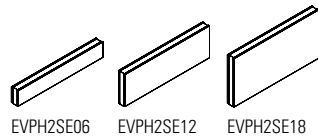

Air Flow Extension Module

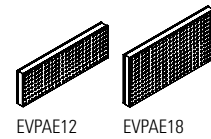

Privacy Glass

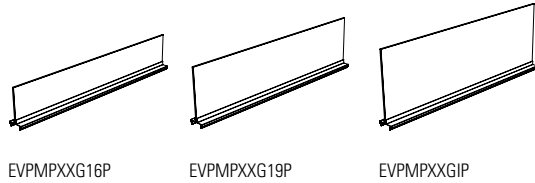

PET Felt

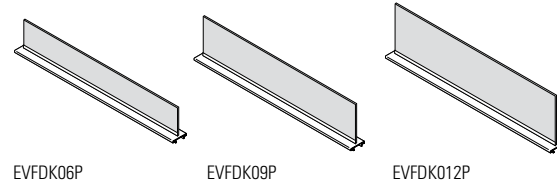



When ordering Beam Extension Modules, Inline Extension Connectors (EVPIEC) must be ordered separately. Please see EVPBIEC for details.

Inline Extension Connectors for Power Beam connect two Beam Extension Modules of equal height in a straight run.

Extension connectors do **not** provide support for hang-on storage components.

EVPFE - FABRIC PANEL EXTENSION MODULE

- Attaches on top of a panel.
- Modules can be stacked to add privacy or divide space.
- Each side of the fabric module may have a different fabric within the same grade at no charge.
- Panel Extension Modules cannot install higher than 42" high above finished floor.
- If different grades of fabric are used on one module, the entire module must be priced at highest grade.
- When ordering Panel Extension Modules, additional connectors are required.
- Fabric on 66" and 72" wide fabric panel extension modules is applied railroaded. Any connecting beams in other widths should be specified with railroaded fabric as well to match.
- *Top Trims are not included with Extension Modules.

	DESCRIPTION	PRODUCT CODE	LIST PRICE		DIMENSIONS/INCHES		
			Gr1	Gr2	H	W	D
	Fabric Panel Extension Module - 6" High	EVPFE0636	244	265	6	36	2 7/8
		EVPFE0642	277	295	6	42	2 7/8
		EVPFE0648	297	320	6	48	2 7/8
		EVPFE0654	320	346	6	54	2 7/8
		EVPFE0660	344	373	6	60	2 7/8
		EVPFE0666	365	398	6	66	2 7/8
		EVPFE0672	388	422	6	72	2 7/8
	Fabric Panel Extension Module - 12" High	EVPFE1236	244	265	12	36	2 7/8
		EVPFE1242	277	295	12	42	2 7/8
		EVPFE1248	297	320	12	48	2 7/8
		EVPFE1254	320	346	12	54	2 7/8
		EVPFE1260	344	373	12	60	2 7/8
		EVPFE1266	365	398	12	66	2 7/8
		EVPFE1272	388	422	12	72	2 7/8
	Fabric Panel Extension Module - 18" High	EVPFE1836	312	342	18	36	2 7/8
		EVPFE1842	342	380	18	42	2 7/8
		EVPFE1848	374	413	18	48	2 7/8
		EVPFE1854	405	449	18	54	2 7/8
		EVPFE1860	440	488	18	60	2 7/8
		EVPFE1866	475	527	18	66	2 7/8
		EVPFE1872	506	563	18	72	2 7/8
	Fabric Panel Extension Module - 24" High	EVPFE2436	312	342	24	36	2 7/8
		EVPFE2442	342	380	24	42	2 7/8
		EVPFE2448	374	413	24	48	2 7/8
		EVPFE2454	405	449	24	54	2 7/8
		EVPFE2460	440	488	24	60	2 7/8
		EVPFE2466	475	526	24	66	2 7/8
		EVPFE2472	506	563	24	72	2 7/8

EVPGTE - TEMPERED GLASS PANEL EXTENSION MODULE

- Attaches on top of beam.
- Modules can be stacked to add privacy or to divide space.
- Panel Extension Modules cannot install higher than 42" h above finished floor
- Standard in clear (CLR) glass.
- Frosted Glass (FRST) 20% upcharge. Contact EVOLVE Customer Support for details.
- When ordering Panel Extension Modules, additional connectors are required.
- *Top Trims are not included with Extension Modules.

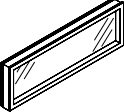
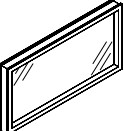
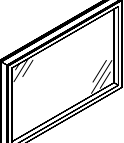
	DESCRIPTION	PRODUCT CODE	LIST PRICE	DIMENSIONS/INCHES		
				H	W	D
	Tempered Glass Panel Extension Module - 6" High	EVPGTE0636	515	6	36	2 7/8
		EVPGTE0642	630	6	42	2 7/8
		EVPGTE0648	702	6	48	2 7/8
		EVPGTE0654	768	6	54	2 7/8
		EVPGTE0660	828	6	60	2 7/8
		EVPGTE0666	886	6	66	2 7/8
		EVPGTE0672	950	6	72	2 7/8
	Tempered Glass Panel Extension Module - 12" High	EVPGTE1236	515	12	36	2 7/8
		EVPGTE1242	630	12	42	2 7/8
		EVPGTE1248	702	12	48	2 7/8
		EVPGTE1254	768	12	54	2 7/8
		EVPGTE1260	828	12	60	2 7/8
		EVPGTE1266	886	12	66	2 7/8
		EVPGTE1272	950	12	72	2 7/8
	Tempered Glass Panel Extension Module - 18" High	EVPGTE1836	686	18	36	2 7/8
		EVPGTE1842	777	18	42	2 7/8
		EVPGTE1848	870	18	48	2 7/8
		EVPGTE1854	944	18	54	2 7/8
		EVPGTE1860	1013	18	60	2 7/8
		EVPGTE1866	1080	18	66	2 7/8
		EVPGTE1872	1153	18	72	2 7/8
	Tempered Glass Panel Extension Module - 24" High	EVPGTE2436	686	24	36	2 7/8
		EVPGTE2442	777	24	42	2 7/8
		EVPGTE2448	870	24	48	2 7/8
		EVPGTE2454	944	24	54	2 7/8
		EVPGTE2460	1013	24	60	2 7/8
		EVPGTE2466	1080	24	66	2 7/8
		EVPGTE2472	1153	24	72	2 7/8

EVPW1SE - WRITE BOARD EXTENSION MODULE - SINGLE SIDED

- Attaches on top of a beam.
- Provides writing surface on one side and fabric on the other side.
- Modules can be stacked to add privacy or to divide space.
- Panel Extension Modules cannot install higher than 42" high above finished floor.
- When ordering Beam Extension Modules, additional connectors are required.
- *Top Trims are not included with Extension Modules.

	DESCRIPTION	PRODUCT CODE	LIST PRICE		DIMENSIONS/INCHES		
			Gr1	Gr2	H	W	D
	Write Board Extension Module - Single Sided 6" High	EVPW1SE0636	397	408	6	36	2 7/8
		EVPW1SE0642	450	456	6	42	2 7/8
		EVPW1SE0648	489	502	6	48	2 7/8
		EVPW1SE0654	552	565	6	54	2 7/8
		EVPW1SE0660	580	593	6	60	2 7/8
		EVPW1SE0666	607	619	6	66	2 7/8
		EVPW1SE0672	671	681	6	72	2 7/8
	Write Board Extension Module - Single Sided 12" High	EVPW1SE1236	397	408	12	36	2 7/8
		EVPW1SE1242	450	456	12	42	2 7/8
		EVPW1SE1248	489	502	12	48	2 7/8
		EVPW1SE1254	552	565	12	54	2 7/8
		EVPW1SE1260	580	593	12	60	2 7/8
		EVPW1SE1266	607	619	12	66	2 7/8
		EVPW1SE1272	671	681	12	72	2 7/8
	Write Board Extension Module - Single Sided 18" High	EVPW1SE1836	433	448	18	36	2 7/8
		EVPW1SE1842	485	503	18	42	2 7/8
		EVPW1SE1848	532	551	18	48	2 7/8
		EVPW1SE1854	579	598	18	54	2 7/8
		EVPW1SE1860	623	645	18	60	2 7/8
		EVPW1SE1866	669	693	18	66	2 7/8
		EVPW1SE1872	715	739	18	72	2 7/8
	Write Board Extension Module - Single Sided 24" High	EVPW1SE2436	433	450	24	36	2 7/8
		EVPW1SE2442	485	505	24	42	2 7/8
		EVPW1SE2448	532	553	24	48	2 7/8
		EVPW1SE2454	579	598	24	54	2 7/8
		EVPW1SE2460	623	646	24	60	2 7/8
		EVPW1SE2466	669	697	24	66	2 7/8
		EVPW1SE2472	715	742	24	72	2 7/8

EVPW2SE - WRITE BOARD EXTENSION MODULE - DOUBLE SIDED

- Attaches on top of a panel.
- Provides writing surface on two sides.
- Modules can be stacked to add privacy or to divide space.
- Panel Extension Modules cannot install higher than 42" above finished floor
- When ordering Panel Extension Modules, additional connectors are required.
- *Top Trims are not included with Extension Modules.

	DESCRIPTION	PRODUCT CODE	LIST PRICE	DIMENSIONS/INCHES		
				H	W	D
	Write Board Extension Module - Double Sided - 6"High	EVPW2SE0636	452	6	36	2 7/8
		EVPW2SE0642	513	6	42	2 7/8
		EVPW2SE0648	572	6	48	2 7/8
		EVPW2SE0654	660	6	54	2 7/8
		EVPW2SE0660	677	6	60	2 7/8
		EVPW2SE0666	692	6	66	2 7/8
		EVPW2SE0672	782	6	72	2 7/8
	Write Board Extension Module - Double Sided - 12"High	EVPW2SE1236	452	12	36	2 7/8
		EVPW2SE1242	513	12	42	2 7/8
		EVPW2SE1248	572	12	48	2 7/8
		EVPW2SE1254	660	12	54	2 7/8
		EVPW2SE1260	677	12	60	2 7/8
		EVPW2SE1266	692	12	66	2 7/8
		EVPW2SE1272	782	12	72	2 7/8
	Write Board Extension Module - Double Sided - 18"High	EVPW2SE1836	552	18	36	2 7/8
		EVPW2SE1842	623	18	42	2 7/8
		EVPW2SE1848	695	18	48	2 7/8
		EVPW2SE1854	769	18	54	2 7/8
		EVPW2SE1860	839	18	60	2 7/8
		EVPW2SE1866	909	18	66	2 7/8
		EVPW2SE1872	983	18	72	2 7/8
	Write Board Extension Module - Double Sided - 24"High	EVPW2SE2436	552	24	36	2 7/8
		EVPW2SE2442	623	24	42	2 7/8
		EVPW2SE2448	695	24	48	2 7/8
		EVPW2SE2454	769	24	54	2 7/8
		EVPW2SE2460	839	24	60	2 7/8
		EVPW2SE2466	909	24	66	2 7/8
		EVPW2SE2472	983	24	72	2 7/8

EVPH1SE - LAMINATE EXTENSION MODULE - SINGLE SIDED

- Attaches on top of a beam.
- Laminate module provides a durable, washable surface on one side and fabric on the other side.
- Modules can be stacked to add privacy or to divide space.
- Panel Extension Modules cannot install higher than 42”h above finished floor.
- When ordering Panel Extension Modules, additional connectors are required.
- Available in high pressure laminate finishes only.
- *Top Trims are not included with Extension Modules.

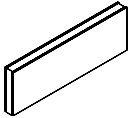
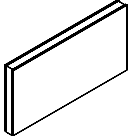
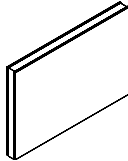
	DESCRIPTION	PRODUCT CODE	LIST PRICE		DIMENSIONS/INCHES		
			Gr1	Gr2	H	W	D
	Laminate Extension Module - Single Sided	EVPH1SE0636	397	403	6	36	2 7/8
		EVPH1SE0642	450	453	6	42	2 7/8
		EVPH1SE0648	489	503	6	48	2 7/8
		EVPH1SE0654	552	565	6	54	2 7/8
		EVPH1SE0660	580	586	6	60	2 7/8
		EVPH1SE0666	607	619	6	66	2 7/8
		EVPH1SE0672	671	681	6	72	2 7/8
	Laminate Extension Module - Single Sided	EVPH1SE1236	397	411	12	36	2 7/8
		EVPH1SE1242	450	460	12	42	2 7/8
		EVPH1SE1248	489	504	12	48	2 7/8
		EVPH1SE1254	552	567	12	54	2 7/8
		EVPH1SE1260	580	595	12	60	2 7/8
		EVPH1SE1266	607	619	12	66	2 7/8
		EVPH1SE1272	671	681	12	72	2 7/8
	Laminate Extension Module - Single Sided	EVPH1SE1836	557	572	18	36	2 7/8
		EVPH1SE1842	629	644	18	42	2 7/8
		EVPH1SE1848	690	707	18	48	2 7/8
		EVPH1SE1854	746	768	18	54	2 7/8
		EVPH1SE1860	821	844	18	60	2 7/8
		EVPH1SE1866	893	922	18	66	2 7/8
		EVPH1SE1872	657	667	18	72	2 7/8
	Laminate Extension Module - Single Sided	EVPH1SE2436	557	576	24	36	2 7/8
		EVPH1SE2442	629	648	24	42	2 7/8
		EVPH1SE2448	690	710	24	48	2 7/8
		EVPH1SE2454	746	772	24	54	2 7/8
		EVPH1SE2460	821	848	24	60	2 7/8
		EVPH1SE2466	893	923	24	66	2 7/8
		EVPH1SE2472	966	984	24	72	2 7/8

EVPH2SE - LAMINATE EXTENSION MODULE - DOUBLE SIDED

- Attaches on top of a beam.
- Laminate faces on both sides of the module provide durable, washable surfaces
- Modules can be stacked to add privacy or to divide space.
- Panel Extension Modules cannot install higher than 42”h above finished floor.
- When ordering Panel Extension Modules, additional connectors are required.
- Available in high pressure laminate finishes only.
- *Top Trims are not included with Extension Modules.

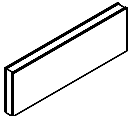
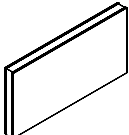
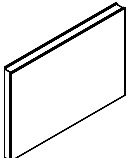
	DESCRIPTION	PRODUCT CODE	LIST PRICE	DIMENSIONS/INCHES		
				H	W	D
	Laminate Extension Module - Double Sided	EVPH2SE0636	452	6	36	2 7/8
		EVPH2SE0642	513	6	42	2 7/8
		EVPH2SE0648	572	6	48	2 7/8
		EVPH2SE0654	660	6	54	2 7/8
		EVPH2SE0660	677	6	60	2 7/8
		EVPH2SE0666	692	6	66	2 7/8
		EVPH2SE0672	782	6	72	2 7/8
	Laminate Extension Module - Double Sided	EVPH2SE1236	452	12	36	2 7/8
		EVPH2SE1242	513	12	42	2 7/8
		EVPH2SE1248	572	12	48	2 7/8
		EVPH2SE1254	660	12	54	2 7/8
		EVPH2SE1260	677	12	60	2 7/8
		EVPH2SE1266	692	12	66	2 7/8
		EVPH2SE1272	782	12	72	2 7/8
	Laminate Extension Module - Double Sided	EVPH2SE1836	674	18	36	2 7/8
		EVPH2SE1842	760	18	42	2 7/8
		EVPH2SE1848	862	18	48	2 7/8
		EVPH2SE1854	944	18	54	2 7/8
		EVPH2SE1860	1017	18	60	2 7/8
		EVPH2SE1866	1090	18	66	2 7/8
		EVPH2SE1872	1174	18	72	2 7/8
	Laminate Extension Module - Double Sided	EVPH2SE2436	674	24	36	2 7/8
		EVPH2SE2442	760	24	42	2 7/8
		EVPH2SE2448	862	24	48	2 7/8
		EVPH2SE2454	944	24	54	2 7/8
		EVPH2SE2460	1017	24	60	2 7/8
		EVPH2SE2466	1090	24	66	2 7/8
		EVPH2SE2472	1174	24	72	2 7/8

EVPAE - AIR FLOW EXTENSION MODULE

- Metal air flow panel extension.
- Attaches to top of beam.
- Modules can be stacked to add privacy or to divide space.
- Panel Extension Modules cannot install higher than 42" h above finished floor.
- When ordering Panel Extension Modules, additional connectors are required.
- *Top Trims are not included with Extension Modules.

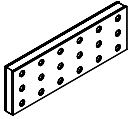
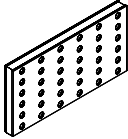
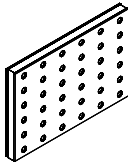
	DESCRIPTION	PRODUCT CODE	LIST PRICE	DIMENSIONS/INCHES		
				H	W	D
	Air Flow Extension Module - 12" High	EVPAE1236	470	12	36	2 7/8
		EVPAE1242	518	12	42	2 7/8
		EVPAE1248	587	12	48	2 7/8
		EVPAE1254	678	12	54	2 7/8
		EVPAE1260	772	12	60	2 7/8
		EVPAE1266	867	12	66	2 7/8
		EVPAE1272	954	12	72	2 7/8
	Air Flow Extension Module - 18" High	EVPAE1836	565	18	36	2 7/8
		EVPAE1842	619	18	42	2 7/8
		EVPAE1848	712	18	48	2 7/8
		EVPAE1854	818	18	54	2 7/8
		EVPAE1860	919	18	60	2 7/8
		EVPAE1866	1021	18	66	2 7/8
		EVPAE1872	1127	18	72	2 7/8
	Air Flow Extension Module - 24" High	EVPAE2436	565	24	24	2 7/8
		EVPAE2442	619	24	42	2 7/8
		EVPAE2448	712	24	48	2 7/8
		EVPAE2454	810	24	54	2 7/8
		EVPAE2460	919	24	60	2 7/8
		EVPAE2466	1021	24	66	2 7/8
		EVPAE2472	1127	24	72	2 7/8

EVPOE - OPEN PANEL EXTENSION MODULE

- Attaches to top portion of a beam.
- Modules can be stacked to add privacy or to divide space
- Panel Extension Modules cannot install higher than 42”h above finished floor.
- When ordering Panel Extension Modules, additional connectors are required.
- *Top Trims are not included with Extension Modules.

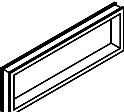
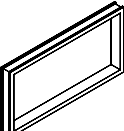
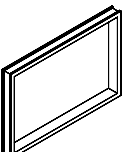
	DESCRIPTION	PRODUCT CODE	LIST PRICE	DIMENSIONS/INCHES		
				H	W	D
	Open Panel Extension Module - 6" High	EVPOE0636	403	6	36	2 7/8
		EVPOE0642	488	6	42	2 7/8
		EVPOE0648	548	6	48	2 7/8
		EVPOE0654	598	6	54	2 7/8
		EVPOE0660	645	6	60	2 7/8
		EVPOE0666	694	6	66	2 7/8
		EVPOE0672	744	6	72	2 7/8
	Open Panel Extension Module - 12" High	EVPOE1236	403	12	36	2 7/8
		EVPOE1242	488	12	42	2 7/8
		EVPOE1248	549	12	48	2 7/8
		EVPOE1254	598	12	54	2 7/8
		EVPOE1260	647	12	60	2 7/8
		EVPOE1266	694	12	66	2 7/8
		EVPOE1272	744	12	72	2 7/8
	Open Panel Extension Module - 18" High	EVPOE1836	534	18	36	2 7/8
		EVPOE1842	601	18	42	2 7/8
		EVPOE1848	678	18	48	2 7/8
		EVPOE1854	735	18	54	2 7/8
		EVPOE1860	791	18	60	2 7/8
		EVPOE1866	850	18	66	2 7/8
		EVPOE1872	906	18	72	2 7/8
	Open Panel Extension Module - 24" High	EVPOE2436	534	24	36	2 7/8
		EVPOE2442	601	24	42	2 7/8
		EVPOE2448	678	24	48	2 7/8
		EVPOE2454	735	24	54	2 7/8
		EVPOE2460	791	24	60	2 7/8
		EVPOE2466	850	24	66	2 7/8
		EVPOE2472	906	24	72	2 7/8

PRIVACY GLASS DIVIDER

EVPMPXXGI6P - 6" H BEAM MOUNT PRIVACY GLASS W/ ALUMINUM TRIM

- Attaches on top of Power Beam or extension modules to add privacy or divide space.
- Privacy Glass is integrated into the aluminum top trim.
- Includes aluminum trim with channel and glass tile.
- Glass and attachment hardware ship separately.
- Standard in clear (CLR) or frosted (FRST) glass.
- Privacy glass modules may stack on top of Power Beam or extension modules at 42" high to achieve a height up to 54"h above finished floor.
- *Top Trims are not included with Extension Modules.

	DESCRIPTION	PRODUCT CODE	LIST PRICE		DIMENSIONS/INCHES		
			CLR	FRST ADD	H	W	D
	6" H Panel Mount Privacy Glass w/ Aluminum Trim - 36" Wide	EVPMP36GI6P	359	38	6	36	2 7/8
	6" H Panel Mount Privacy Glass w/ Aluminum Trim - 42" Wide	EVPMP42GI6P	375	63	6	42	2 7/8
	6" H Panel Mount Privacy Glass w/ Aluminum Trim - 48" Wide	EVPMP48GI6P	385	80	6	48	2 7/8
	6" H Panel Mount Privacy Glass w/ Aluminum Trim - 54" Wide	EVPMP54GI6P	399	100	6	54	2 7/8
	6" H Panel Mount Privacy Glass w/ Aluminum Trim - 60" Wide	EVPMP60GI6P	410	132	6	60	2 7/8
	6" H Panel Mount Privacy Glass w/ Aluminum Trim - 66" Wide	EVPMP66GI6P	475	158	6	66	2 7/8
	6" H Panel Mount Privacy Glass w/ Aluminum Trim - 72" Wide	EVPMP72GI6P	488	158	6	72	2 7/8

EVPMPXXGI9P - 9" H BEAM MOUNT PRIVACY GLASS W/ ALUMINUM TRIM

- Attaches on top of Power Beam or extension modules to add privacy or divide space.
- Privacy Glass is integrated into the aluminum top trim.
- Includes aluminum trim with channel and glass tile.
- Glass and attachment hardware ship separately.
- Standard in clear (CLR) or frosted (FRST) glass.
- Privacy glass modules may stack on top of Power Beam or extension modules at 42" high to achieve a height up to 54"h above finished floor.
- *Top Trims are not included with Extension Modules.

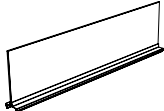
	DESCRIPTION	PRODUCT CODE	LIST PRICE		DIMENSIONS/INCHES		
			CLR	FRST ADD	H	W	D
 36"W Shown	9" H Panel Mount Privacy Glass w/ Aluminum Trim - 36" Wide	EVPMP36GI9P	359	38	9	36	2 7/8
	9" H Panel Mount Privacy Glass w/ Aluminum Trim - 42" Wide	EVPMP42GI9P	375	63	9	42	2 7/8
	9" H Panel Mount Privacy Glass w/ Aluminum Trim - 48" Wide	EVPMP48GI9P	385	80	9	48	2 7/8
	9" H Panel Mount Privacy Glass w/ Aluminum Trim - 54" Wide	EVPMP54GI9P	399	100	9	54	2 7/8
	9" H Panel Mount Privacy Glass w/ Aluminum Trim - 60" Wide	EVPMP60GI9P	410	132	9	60	2 7/8
	9" H Panel Mount Privacy Glass w/ Aluminum Trim - 66" Wide	EVPMP66GI9P	475	158	9	66	2 7/8
	9" H Panel Mount Privacy Glass w/ Aluminum Trim - 72" Wide	EVPMP72GI9P	488	158	9	72	2 7/8

PRIVACY GLASS DIVIDER

EVPMPXXGIP - 12" PANEL MOUNT PRIVACY GLASS W/ ALUMINUM TRIM

- Attaches on top of Evolve Panels to add privacy or divide space.
- Privacy Glass is integrated into the aluminum top trim.
- Includes aluminum trim with channel and glass tile.
- Standard in clear (CLR), frosted (FRST) or writeable (WRW) glass.

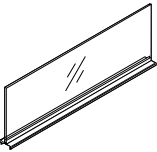
	DESCRIPTION	PRODUCT CODE	LIST PRICE			DIMENSIONS/INCHES		
			CLR	FRST ADD	WRW ADD	H	W	D
	Panel Mount Privacy Glass w/ Aluminum Trim - 36" Wide	EVPMP36GIP	359	38	171	12	36	2 7/8
	Panel Mount Privacy Glass w/ Aluminum Trim - 42" Wide	EVPMP42GIP	375	63	206	12	42	2 7/8
	Panel Mount Privacy Glass w/ Aluminum Trim - 48" Wide	EVPMP48GIP	395	80	240	12	48	2 7/8
	Panel Mount Privacy Glass w/ Aluminum Trim - 54" Wide	EVPMP54GIP	411	102	275	12	54	2 7/8
	Panel Mount Privacy Glass w/ Aluminum Trim - 60" Wide	EVPMP60GIP	423	132	316	12	60	2 7/8
	Panel Mount Privacy Glass w/ Aluminum Trim - 66" Wide	EVPMP66GIP	475	158	368	12	66	2 7/8
	Panel Mount Privacy Glass w/ Aluminum Trim - 72" Wide	EVPMP72GIP	503	158	377	12	72	2 7/8

EVPMPXXGI18P - 18" H PANEL MOUNT PRIVACY GLASS

- Privacy Glass integrated with aluminum top trim.
- Attaches on top of panels to add privacy or divide space.
- Includes aluminum trim with channel and glass tile.
- Glass and attachment hardware to ship separately.

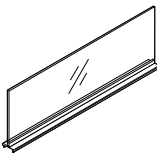
	DESCRIPTION	PRODUCT CODE	LIST PRICE		DIMENSIONS/INCHES		
			CLR	FRST ADD	H	W	D
	18" H Panel Mount Privacy Glass w/ Aluminum Trim - 36" Wide	EVPMP36G118P	537	54	18	36	2 7/8
	18" H Panel Mount Privacy Glass w/ Aluminum Trim - 42" Wide	EVPMP42G118P	560	90	18	42	2 7/8
	18" H Panel Mount Privacy Glass w/ Aluminum Trim - 48" Wide	EVPMP48G118P	593	117	18	48	2 7/8
	18" H Panel Mount Privacy Glass w/ Aluminum Trim - 54" Wide	EVPMP54G118P	615	156	18	54	2 7/8
	18" H Panel Mount Privacy Glass w/ Aluminum Trim - 60" Wide	EVPMP60G118P	635	195	18	60	2 7/8
	18" H Panel Mount Privacy Glass w/ Aluminum Trim - 66" Wide	EVPMP66G118P	712	232	18	66	2 7/8
	18" H Panel Mount Privacy Glass w/ Aluminum Trim - 72" Wide	EVPMP72G118P	753	233	18	72	2 7/8

PRIVACY GLASS DIVIDER

EVPMPNXXGI18P - 18" H PANEL MOUNT PRIVACY GLASS WITH NOTCHED TOP TRIM FOR VARIABLE HEIGHT CONNECTOR

- Privacy Glass integrated with aluminum top trim.
- Attaches on top of panels to add privacy or divide space.
- Includes aluminum trim with channel and glass tile.
- Standard in clear (CLR) or frosted (FRST) glass.
- Glass and attachment hardware to ship separately.

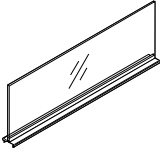
	DESCRIPTION	PRODUCT CODE	LIST PRICE		DIMENSIONS/INCHES		
			CLR	FRST ADD	H	W	D
	18" H Panel Mount Privacy Glass w/ Aluminum Trim - 36" Wide	EVPMPN36G118P	537	54	18	36	2 7/8
	18" H Panel Mount Privacy Glass w/ Aluminum Trim - 42" Wide	EVPMPN42G118P	560	90	18	42	2 7/8
	18" H Panel Mount Privacy Glass w/ Aluminum Trim - 48" Wide	EVPMPN48G118P	593	117	18	48	2 7/8
	18" H Panel Mount Privacy Glass w/ Aluminum Trim - 54" Wide	EVPMPN54G118P	615	156	18	54	2 7/8
	18" H Panel Mount Privacy Glass w/ Aluminum Trim - 60" Wide	EVPMPN60G118P	635	195	18	60	2 7/8
	18" H Panel Mount Privacy Glass w/ Aluminum Trim - 66" Wide	EVPMPN66G118P	712	232	18	66	2 7/8
	18" H Panel Mount Privacy Glass w/ Aluminum Trim - 72" Wide	EVPMPN72G118P	753	233	18	72	2 7/8

PRIVACY GLASS DIVIDER

EVPMPDNXXGI18P-18"H PANEL MOUNT PRIVACY GLASS WITH DOUBLE NOTCHED TOP TRIM FOR VARIABLE HEIGHT CONNECTOR

- Privacy Glass integrated with aluminum top trim.
- Attaches on top of panels to add privacy or divide space.
- Includes aluminum trim with channel and glass tile.
- Standard in clear (CLR) or frosted (FRST) glass.
- Glass and attachment hardware to ship separately.

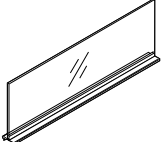
	DESCRIPTION	PRODUCT CODE	LIST PRICE		DIMENSIONS/INCHES		
			CLR	FRST ADD	H	W	D
	18" H Panel Mount Privacy Glass w/ Aluminum Trim - 36" Wide	EVPMPDN36GI18P	537	54	18	36	2 7/8
	18" H Panel Mount Privacy Glass w/ Aluminum Trim - 42" Wide	EVPMPDN42GI18P	560	90	18	42	2 7/8
	18" H Panel Mount Privacy Glass w/ Aluminum Trim - 48" Wide	EVPMPDN48GI18P	593	117	18	48	2 7/8
	18" H Panel Mount Privacy Glass w/ Aluminum Trim - 54" Wide	EVPMPDN54GI18P	615	156	18	54	2 7/8
	18" H Panel Mount Privacy Glass w/ Aluminum Trim - 60" Wide	EVPMPDN60GI18P	635	195	18	60	2 7/8
	18" H Panel Mount Privacy Glass w/ Aluminum Trim - 66" Wide	EVPMPDN66GI18P	712	232	18	66	2 7/8
	18" H Panel Mount Privacy Glass w/ Aluminum Trim - 72" Wide	EVPMPDN72GI18P	753	233	18	72	2 7/8

PRIVACY GLASS DIVIDER

EVMPMPXXGI6W - 6" H PRIVACY GLASS W/ ALUMINUM TRIM FOR 1" LAMINATE PANEL

- Attaches on top of Evolve 1" Laminate Panels to add privacy or divide space.
- Privacy Glass is integrated into the aluminum top trim.
- Aluminum trim has rail for accessories.
- Includes aluminum trim with end caps and glass tile
- Glass and attachment hardware ship separately.
- Standard in clear (CLR) or frosted (FRST) glass.
- *Top Trims are not included with Extension Modules.

	DESCRIPTION	PRODUCT CODE	LIST PRICE		DIMENSIONS/INCHES		
			CLR	FRST ADD	H	W	D
 <p>36"W Shown</p>	6" H Privacy Glass w/ Aluminum Trim for 1" Laminate Panel - 24" Wide	EVMPMP24GI6W	311	73	6	24	1
	6" H Privacy Glass w/ Aluminum Trim for 1" Laminate Panel- 30" Wide	EVMPMP30GI6W	338	53	6	30	1
	6" H Privacy Glass w/ Aluminum Trim for 1" Laminate Panel - 36" Wide	EVMPMP36GI6W	359	38	6	36	1
	6" H Privacy Glass w/ Aluminum Trim for 1" Laminate Panel- 42" Wide	EVMPMP42GI6W	375	63	6	42	1
	6" H Privacy Glass w/ Aluminum Trim for 1" Laminate Panel- 48" Wide	EVMPMP48GI6W	395	80	6	48	1

EVMPMPXXGI9W - 9" H PRIVACY GLASS W/ ALUMINUM TRIM FOR 1" LAMINATE PANEL

- Attaches on top of Evolve 1" Laminate Panels to add privacy or divide space.
- Privacy Glass is integrated into the aluminum top trim.
- Aluminum trim has rail for accessories.
- Includes aluminum trim with end caps and glass tile.
- Glass and attachment hardware ship separately.
- Standard in clear (CLR) or frosted (FRST) glass.
- *Top Trims are not included with Extension Modules.

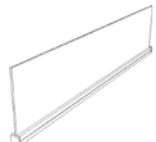
	DESCRIPTION	PRODUCT CODE	LIST PRICE		DIMENSIONS/INCHES		
			CLR	FRST ADD	H	W	D
 <p>36"W Shown</p>	9" H Privacy Glass w/ Aluminum Trim for 1" Laminate Panel - 24" Wide	EVMPMP24GI9W	311	73	9	24	1
	9" H Privacy Glass w/ Aluminum Trim for 1" Laminate Panel- 30" Wide	EVMPMP30GI9W	338	53	9	30	1
	9" H Privacy Glass w/ Aluminum Trim for 1" Laminate Panel - 36" Wide	EVMPMP36GI9W	359	38	9	36	1
	9" H Privacy Glass w/ Aluminum Trim for 1" Laminate Panel- 42" Wide	EVMPMP42GI9W	375	63	9	42	1
	9" H Privacy Glass w/ Aluminum Trim for 1" Laminate Panel- 48" Wide	EVMPMP48GI9W	395	80	9	48	1

PRIVACY GLASS DIVIDER

EVPMPXXGIW - 12" H PRIVACY GLASS W/ ALUMINUM TRIM FOR 1" LAMINATE PANEL

- Attaches on top of Evolve 1" Laminate Panels to add privacy or divide space.
- Privacy Glass is integrated into the aluminum top trim.
- Aluminum trim has rail for accessories.
- Includes aluminum trim with end caps and glass tile
- Glass and attachment hardware ship separately.
- Standard in clear (CLR), frosted (FRST) or writeable (WRW) glass.

	DESCRIPTION	PRODUCT CODE	LIST PRICE			DIMENSIONS/INCHES		
			CLR	FRST	WRW	H	W	D
	12" H Privacy Glass w/ Aluminum Trim for 1" Laminate Panel - 24" Wide	EVPMP24GIW	311	73	196	12	24	1
	12" H Privacy Glass w/ Aluminum Trim for 1" Laminate Panel - 30" Wide	EVPMP30GIW	338	53	180	12	30	1
	12" H Privacy Glass w/ Aluminum Trim for 1" Laminate Panel - 36" Wide	EVPMP36GIW	359	38	170	12	36	1
	12" H Privacy Glass w/ Aluminum Trim for 1" Laminate Panel - 42" Wide	EVPMP42GIW	375	63	206	12	42	1
	12" H Privacy Glass w/ Aluminum Trim for 1" Laminate Panel - 48" Wide	EVPMP48GIW	395	80	239	12	48	1

EVPFDW - 6" H FELT DIVIDER W/ ALUMINUM TRIM FOR 1" LAMINATE PANEL

- Privacy Felt Divider integrated with aluminum top trim.
- Attaches on top of laminate panels to add privacy or divide space.
- Includes aluminum trim with channel and felt tile.
- Felt and attachment hardware to ship separately.
- 9 mm felt material is tackable and available in standard felt colors. Please specify color.
- Aluminum top trim available in standard paint finishes.

	DESCRIPTION	PRODUCT CODE	LIST PRICE	DIMENSIONS/INCHES		
				H	W	D
	6" H Felt Divider w/ Aluminum Trim for 1" Laminate Panel	EVPFD0624W	125	6	24	1
		EVPFD0630W	145	6	30	1
		EVPFD0636W	172	6	36	1
		EVPFD0642W	193	6	42	1
		EVPFD0648W	283	6	48	1
		EVPFD0654W	310	6	54	1
		EVPFD0660W	332	6	60	1
		EVPFD0666W	350	6	66	1
	EVPFD0672W	395	6	72	1	

EVPFDW - 9" H FELT DIVIDER W/ ALUMINUM TRIM FOR 1" LAMINATE PANEL

- Privacy Felt Divider integrated with aluminum top trim.
- Attaches on top of laminate panels to add privacy or divide space.
- Includes aluminum trim with channel and felt tile.
- Felt and attachment hardware to ship separately.
- 9 mm felt material is tackable and available in standard felt colors. Please specify color.
- Aluminum top trim available in standard paint finishes.

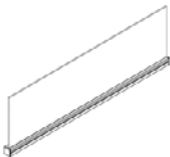
	DESCRIPTION	PRODUCT CODE	LIST PRICE	DIMENSIONS/INCHES		
				H	W	D
	9" H Felt Divider w/ Aluminum Trim for 1" Laminate Panel	EVPFD0924W	125	9	24	1
		EVPFD0930W	145	9	30	1
		EVPFD0936W	172	9	36	1
		EVPFD0942W	193	9	42	1
		EVPFD0948W	283	9	48	1
		EVPFD0954W	310	9	54	1
		EVPFD0960W	332	9	60	1
		EVPFD0966W	350	9	66	1
		EVPFD0972W	395	9	72	1

PET FELT DIVIDER

EVFPDW - 12" H FELT DIVIDER W/ ALUMINUM TRIM FOR 1" LAMINATE PANEL

- Privacy Felt Divider integrated with aluminum top trim.
- Attaches on top of laminate panels to add privacy or divide space.
- Includes aluminum trim with channel and felt tile.
- Felt and attachment hardware to ship separately.
- 9 mm felt material is tackable and available in standard felt colors. Please specify color.
- Aluminum top trim available in standard paint finishes.

DESCRIPTION	PRODUCT CODE	LIST PRICE	DIMENSIONS/INCHES		
			H	W	D
 12" H Felt Divider w/ Aluminum Trim for 1" Laminate Panel	EVFPD1224W	125	12	24	1
	EVFPD1230W	145	12	30	1
	EVFPD1236W	172	12	36	1
	EVFPD1242W	193	12	42	1
	EVFPD1248W	283	12	48	1
	EVFPD1254W	310	12	54	1
	EVFPD1260W	332	12	60	1
	EVFPD1266W	350	12	66	1
	EVFPD1272W	395	12	72	1

EVFPDW - 18" H FELT DIVIDER W/ ALUMINUM TRIM FOR 1" LAMINATE PANEL

- Privacy Felt Divider integrated with aluminum top trim.
- Attaches on top of laminate panels to add privacy or divide space.
- Includes aluminum trim with channel and felt tile.
- Felt and attachment hardware to ship separately.
- 9 mm felt material is tackable and available in standard felt colors. Please specify color.
- Aluminum top trim available in standard paint finishes.

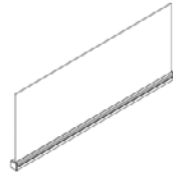
DESCRIPTION	PRODUCT CODE	LIST PRICE	DIMENSIONS/INCHES		
			H	W	D
 18" H Felt Divider w/ Aluminum Trim for 1" Laminate Panel	EVFPD1824W	156	18	24	1
	EVFPD1830W	181	18	30	1
	EVFPD1836W	214	18	36	1
	EVFPD1842W	239	18	42	1
	EVFPD1848W	353	18	48	1
	EVFPD1854W	385	18	54	1
	EVFPD1860W	416	18	60	1
	EVFPD1866W	436	18	66	1
	EVFPD1872W	495	18	72	1

PET FELT DIVIDER

EVFDK06P - 6" PANEL MOUNTED FELT DIVIDER

- Privacy felt panel integrated with aluminum top trim.
- Attaches on top of panels to add privacy or divide space. Includes aluminum trim with channel and felt tile.
- Aluminum trim must be specified for entire station when ordering panel mount privacy felt.
- Felt and attachment hardware to ship separately.
- 9 mm felt material is tackable and available in standard felt colors. Please specify color.

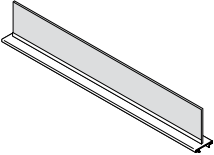
DESCRIPTION	PRODUCT CODE	LIST PRICE Gr1	DIMENSIONS/INCHES		
			H	W	D
 6" Privacy felt panel integrated with aluminum top trim	EVFDK0624P	125	6	24	2 7/8
	EVFDK0630P	145	6	30	2 7/8
	EVFDK0636P	172	6	36	2 7/8
	EVFDK0642P	193	6	42	2 7/8
	EVFDK0648P	283	6	48	2 7/8
	EVFDK0654P	310	6	54	2 7/8
	EVFDK0660P	332	6	60	2 7/8
	EVFDK0666P	350	6	66	2 7/8
	EVFDK0672P	395	6	72	2 7/8

EVFDK09P - 9" PANEL MOUNTED FELT DIVIDER

- Privacy felt panel integrated with aluminum top trim.
- Attaches on top of panels to add privacy or divide space. Includes aluminum trim with channel and felt tile.
- Aluminum trim must be specified for entire station when ordering panel mount privacy felt.
- Felt and attachment hardware to ship separately.
- 9 mm felt material is tackable and available in standard felt colors. Please specify color.

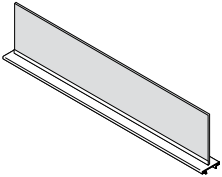
DESCRIPTION	PRODUCT CODE	LIST PRICE Gr1	DIMENSIONS/INCHES		
			H	W	D
 9" Privacy felt panel integrated with aluminum top trim	EVFDK0924P	125	9	24	2 7/8
	EVFDK0930P	145	9	30	2 7/8
	EVFDK0936P	172	9	36	2 7/8
	EVFDK0942P	193	9	42	2 7/8
	EVFDK0948P	283	9	48	2 7/8
	EVFDK0954P	310	9	54	2 7/8
	EVFDK0960P	332	9	60	2 7/8
	EVFDK0966P	350	9	66	2 7/8
	EVFDK0972P	395	9	72	2 7/8

EVFDK12P - 12" PANEL MOUNTED FELT DIVIDER

- Privacy felt panel integrated with aluminum top trim.
- Attaches on top of panels to add privacy or divide space. Includes aluminum trim with channel and felt tile.
- Aluminum trim must be specified for entire station when ordering panel mount privacy felt.
- Felt and attachment hardware to ship separately.
- 9 mm felt material is tackable and available in standard felt colors. Please specify color.

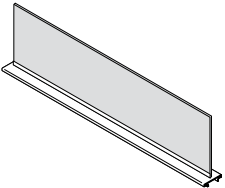
DESCRIPTION	PRODUCT CODE	LIST PRICE Gr1	DIMENSIONS/INCHES		
			H	W	D
 12" Privacy felt panel integrated with aluminum top trim	EVFDK1224P	125	12	24	2 7/8
	EVFDK1230P	145	12	30	2 7/8
	EVFDK1236P	172	12	36	2 7/8
	EVFDK1242P	193	12	42	2 7/8
	EVFDK1248P	283	12	48	2 7/8
	EVFDK1254P	310	12	54	2 7/8
	EVFDK1260P	332	12	60	2 7/8
	EVFDK1266P	350	12	66	2 7/8
	EVFDK1272P	395	12	72	2 7/8

PET FELT DIVIDER

EVFDK12PN - 12" PANEL MOUNTED FELT DIVIDER, 1 NOTCH

- Privacy felt panel integrated with aluminum top trim.
- Attaches on top of panels to add privacy or divide space. Includes aluminum trim with channel and felt tile.
- Aluminum trim must be specified for entire station when ordering panel mount privacy felt.
- Felt and attachment hardware to ship separately.
- 9 mm felt material is tackable and available in standard felt colors. Please specify color.

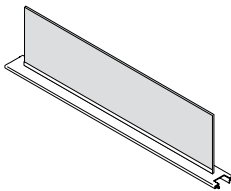
DESCRIPTION	PRODUCT CODE	LIST PRICE Gr1	DIMENSIONS/INCHES		
			H	W	D
 12" Privacy felt panel integrated with aluminum top trim with 1 Notch	EVFDK1224PN	125	12	22.68	2 7/8
	EVFDK1230PN	145	12	28.68	2 7/8
	EVFDK1236PN	172	12	34.68	2 7/8
	EVFDK1242PN	193	12	40.68	2 7/8
	EVFDK1248PN	283	12	46.68	2 7/8
	EVFDK1254PN	310	12	52.68	2 7/8
	EVFDK1260PN	332	12	58.68	2 7/8

EVFDK12PDN - 12" PANEL MOUNTED FELT DIVIDER, 2 NOTCHES

- Privacy felt panel integrated with aluminum top trim.
- Attaches on top of panels to add privacy or divide space. Includes aluminum trim with channel and felt tile.
- Aluminum trim must be specified for entire station when ordering panel mount privacy felt.
- Felt and attachment hardware to ship separately.
- 9 mm felt material is tackable and available in standard felt colors. Please specify color.

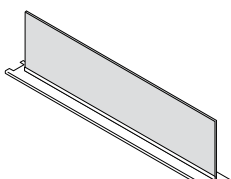
DESCRIPTION	PRODUCT CODE	LIST PRICE Gr1	DIMENSIONS/INCHES		
			H	W	D
 12" Privacy felt panel integrated with aluminum top trim with 2 Notches	EVFDK1224PDN	125	12	21.44	2 7/8
	EVFDK1230PDN	145	12	27.44	2 7/8
	EVFDK1236PDN	172	12	33.44	2 7/8
	EVFDK1242PDN	193	12	39.44	2 7/8
	EVFDK1248PDN	283	12	45.44	2 7/8
	EVFDK1254PDN	310	12	51.44	2 7/8
	EVFDK1260PDN	332	12	57.44	2 7/8

EVFDK18P - 18" PANEL MOUNTED FELT DIVIDER

- Privacy felt panel integrated with aluminum top trim.
- Attaches on top of panels to add privacy or divide space. Includes aluminum trim with channel and felt tile.
- Aluminum trim must be specified for entire station when ordering panel mount privacy felt.
- Felt and attachment hardware to ship separately.
- 9 mm felt material is tackable and available in standard felt colors. Please specify color.

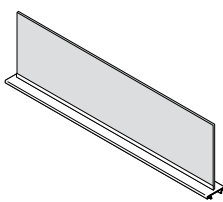
DESCRIPTION	PRODUCT CODE	LIST PRICE Gr1	DIMENSIONS/INCHES		
			H	W	D
 18" Privacy felt panel integrated with aluminum top trim	EVFDK1824P	156	18	24	2 7/8
	EVFDK1830P	181	18	30	2 7/8
	EVFDK1836P	214	18	36	2 7/8
	EVFDK1842P	239	18	42	2 7/8
	EVFDK1848P	353	18	48	2 7/8
	EVFDK1854P	385	18	54	2 7/8
	EVFDK1860P	416	18	60	2 7/8
	EVFDK1866P	436	18	66	2 7/8
	EVFDK1872P	495	18	72	2 7/8

GALLERY PANELS

EVPPGT - GLAZED PRIVACY PANEL

- Includes panel with two connectors with T legs with glides and end of run trims
- 3" thick mobile or freestanding panels.
- 22" deep T-legs for stability (9.5" on each side)
- 66" high. Additional widths, heights and configurations available.
- All Modules are Tempered Glass.
- Includes end of run trim.

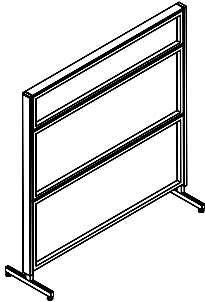
	DESCRIPTION	PRODUCT CODE	LIST PRICE		DIMENSIONS/INCHES		
			CLR	FRST ADD	H	W	D
	Freestanding Glazed Privacy Panel	EVPPGT6660	2173	691	66	60	2 7/8
	Mobile Glazed Privacy Panel	EVPPGT6660M	2245	692	66	60	2 7/8

EVPPHGT - LAMINATE GLAZED PRIVACY PANEL

- Includes panel with two connectors with T legs with glides and end of run trims
- 3" thick mobile or freestanding panels.
- 22" deep T-legs for stability (9.5" on each side)
- 66" high. Additional widths, heights and configurations available.
- Laminate Base Module w/36" Tempered Glass above.
- Includes end of run trim.

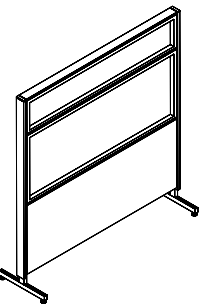
	DESCRIPTION	PRODUCT CODE	LIST PRICE		DIMENSIONS/INCHES		
			CLR	FRST ADD	H	W	D
	Freestanding Laminate Glazed Privacy Panel	EVPPHGT6660	2300	373	66	60	2 7/8
	Mobile Laminate Glazed Privacy Panel	EVPPHGT6660M	2376	373	66	60	2 7/8

EVPPHGTU - LAMINATE GLAZED PRIVACY PANEL

- Includes panel with two connectors with T legs with glides and end of run trims
- 3" thick mobile or freestanding panels.
- 22" deep T-legs for stability (9.5" on each side)
- 66" high. Additional widths, heights and configurations available.
- Bottom Two Modules are Laminate w/12" Tempered Glass on top.
- Includes end of run trim.

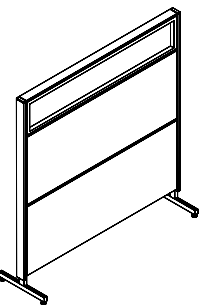
	DESCRIPTION	PRODUCT CODE	LIST PRICE		DIMENSIONS/INCHES		
			CLR	FRST ADD	H	W	D
	Freestanding Laminate Glazed Privacy Panel	EVPPHGTU6660	2430	399	66	60	2 7/8
	Mobile Laminate Glazed Privacy Panel	EVPPHGTU6660M	2505	399	66	60	2 7/8

GALLERY PANELS

EVPPH2S - LAMINATE PRIVACY PANEL

- Includes panel with two connectors with T legs with glides and end of run trims
- 3" thick mobile or freestanding panels.
- 22" deep T-legs for stability (9.5" on each side)
- 66" high. Additional widths, heights and configurations available.
- All Modules are Laminate.
- Includes end of run trim.

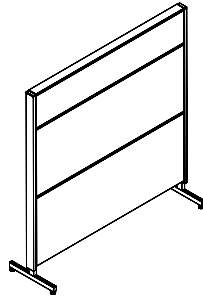

DESCRIPTION	PRODUCT CODE	LIST PRICE	DIMENSIONS/INCHES		
			H	W	D
Freestanding Laminate Privacy Panel	EVPPH2S6660	2463	66	60	2 7/8
Mobile Laminate Privacy Panel	EVPPH2S6660M	2537	66	60	2 7/8

EVPPF2W - WRITE BOARD PRIVACY PANEL

- Includes panel with two connectors with T legs with glides and end of run trims
- 3" thick mobile or freestanding panels.
- 22" deep T-legs for stability (9.5" on each side)
- 66" high. Additional widths, heights and configurations available.
- Fabric Base Module w/36" Writeboard.
- Includes end of run trim.

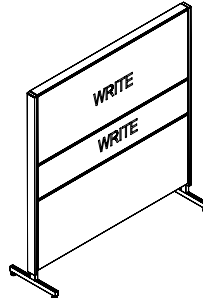

DESCRIPTION	PRODUCT CODE	LIST PRICE		DIMENSIONS/INCHES		
		Gr1	Gr2	H	W	D
Freestanding Write Board Privacy Panel	EVPPF2W6660	2536	2584	66	60	2 7/8
Mobile Write Board Privacy Panel	EVPPF2W6660M	2611	2659	66	60	2 7/8

EVPPH2W - WRITE BOARD PRIVACY PANEL

- Includes panel with two connectors with T legs with glides and end of run trims
- 3" thick mobile or freestanding panels.
- 22" deep T-legs for stability (9.5" on each side)
- 66" high. Additional widths, heights and configurations available.
- Laminate Base Module w/36" Writeboard.
- Includes end of run trim.

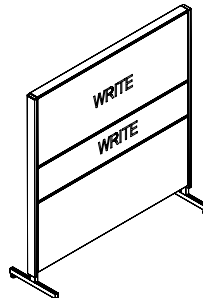

DESCRIPTION	PRODUCT CODE	LIST PRICE	DIMENSIONS/INCHES		
			H	W	D
Freestanding Write Board Privacy Panel	EVPPH2W6660	2725	66	60	2 7/8
Mobile Write Board Privacy Panel	EVPPH2W6660M	2799	66	60	2 7/8

GALLERY PANELS

EVPP - FREESTANDING GLAZED PRIVACY PANEL

- Includes panel with two connectors with T legs.
- 3" thick freestanding panels with leveling glides.
- 22" deep T-legs for stability (9.5" on each side)
- All Modules are Tempered Glass.
- Includes end of run trim.

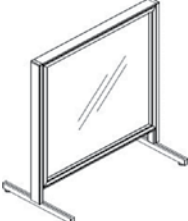
DESCRIPTION	PRODUCT CODE	LIST PRICE		DIMENSIONS/INCHES		
		CLR	FRST ADD	H	W	D
 Freestanding Glazed Monolithic Privacy Panel	EVPPXGT4218	766	159	42	18	2 7/8
	EVPPXGT4224	843	193	42	24	2 7/8
	EVPPXGT4230	915	218	42	30	2 7/8
	EVPPXGT4236	985	246	42	36	2 7/8
	EVPPXGT4242	1064	279	42	42	2 7/8

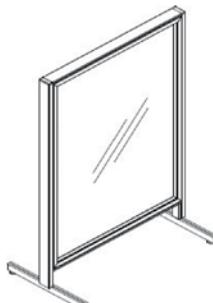
DESCRIPTION	PRODUCT CODE	LIST PRICE		DIMENSIONS/INCHES		
		CLR	FRST ADD	H	W	D
 Freestanding Glazed Monolithic Privacy Panel	EVPPXGT5418	892	194	54	18	2 7/8
	EVPPXGT5424	984	228	54	24	2 7/8
	EVPPXGT5430	1069	265	54	30	2 7/8
	EVPPXGT5436	1151	299	54	36	2 7/8
	EVPPXGT5442	1243	336	54	42	2 7/8

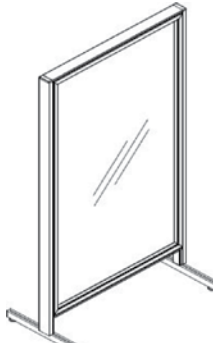
DESCRIPTION	PRODUCT CODE	LIST PRICE		DIMENSIONS/INCHES		
		CLR	FRST ADD	H	W	D
 Freestanding Glazed Monolithic Privacy Panel	EVPPXGT6618	1028	234	66	18	2 7/8
	EVPPXGT6624	1128	273	66	24	2 7/8
	EVPPXGT6630	1231	312	66	30	2 7/8
	EVPPXGT6636	1324	350	66	36	2 7/8
	EVPPXGT6642	1434	395	66	42	2 7/8

GALLERY PANELS

EVPP - GLAZED MOBILE PRIVACY PANEL

- Includes panel with two connectors with T legs.
- 3" thick freestanding panels with 1" locking casters.
- 22" deep T-legs for stability (9.5" on each side)
- All Modules are Tempered Glass.
- Includes end of run trim.
-

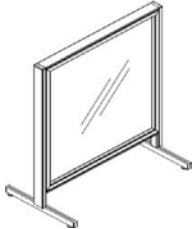
DESCRIPTION	PRODUCT CODE	LIST PRICE		DIMENSIONS/INCHES		
		CLR	FRST ADD	H	W	D
 Monolithic Mobile Glazed Privacy Panel	EVPPXGT4218M	842	159	42	18	2 7/8
	EVPPXGT4224M	919	192	42	24	2 7/8
	EVPPXGT4230M	991	218	42	30	2 7/8
	EVPPXGT4236M	1059	246	42	36	2 7/8
	EVPPXGT4242M	1138	278	42	42	2 7/8

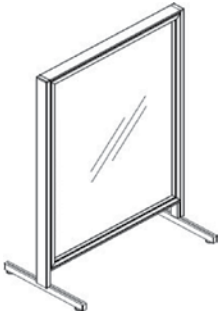
DESCRIPTION	PRODUCT CODE	LIST PRICE			DIMENSIONS/INCHES		
		CLR	FRST ADD	WRW ADD	H	W	D
 Mobile Glazed Monolithic Privacy Panel	EVPPXGT5418M	969	194	651	54	18	2 7/8
	EVPPXGT5424M	1058	232	806	54	24	2 7/8
	EVPPXGT5430M	1144	265	957	54	30	2 7/8
	EVPPXGT5436M	1227	299	1111	54	36	2 7/8
	EVPPXGT5442M	1319	335	1266	54	42	2 7/8

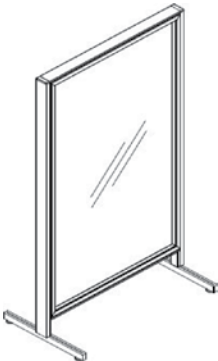
DESCRIPTION	PRODUCT CODE	LIST PRICE			DIMENSIONS/INCHES		
		CLR	FRST ADD	WRW ADD	H	W	D
 Mobile Glazed Monolithic Privacy Panel	EVPPXGT6618M	1102	234	801	66	18	2 7/8
	EVPPXGT6624M	1203	273	988	66	24	2 7/8
	EVPPXGT6630M	1305	313	1174	66	30	2 7/8
	EVPPXGT6636M	1399	351	1358	66	36	2 7/8
	EVPPXGT6642M	1509	395	1551	66	42	2 7/8

GALLERY PANELS

EVPBLERT - END OF RUN TRIM

- Specify to match height of beam or total height with extension modules

DESCRIPTION	PRODUCT CODE	LIST PRICE	DIMENSIONS/INCHES		
			H	W	D
	EVPBLERT24	58	21.4	2 7/8	
	EVPBLERT30	79	27.4	2 7/8	
	EVPBLERT36	83	33.4	2 7/8	
	EVPBLERT42	88	39.4	2 7/8	

GALLERY PANELS

EVPBLEPDSNC - POWER BEAM LAMINATE DOUBLE SIDED GALLERY PANEL, FINISHED ENDS

- Attaches to power beam channel.
- To be installed at end of power beam run.
- Finished in thermally fused laminate.
- No connection both sides.
- Laminate Gallery Panel height is inclusive of panel glides extended to their full height.
- If wood grain is selected, grain runs horizontally.
- Power beam channel and bottom connecting bracket to be ordered separately.

	DESCRIPTION	PRODUCT CODE	LIST PRICE LP	DIMENSIONS/INCHES		
				H	W	D
	Laminate Double Sided Connecting Gallery Panel - Finished Ends - 42" High	EVPBLEPDS4251NC	741	42	51	1
		EVPBLEPDS4263NC	963	42	63	1
		EVPBLEPDS4275NC	1188	42	75	1
	Laminate Double Sided Connecting Gallery Panel - Finished Ends - 48" High	EVPBLEPDS4851NC	807	48	51	1
		EVPBLEPDS4863NC	1069	48	63	1
		EVPBLEPDS4875NC	1299	48	75	1
	Laminate Double Sided Connecting Gallery Panel - Finished Ends - 54" High	EVPBLEPDS5451NC	937	54	51	1
		EVPBLEPDS5463NC	1224	54	63	1
		EVPBLEPDS5475NC	1415	54	75	1

EVPBLEPDS - POWER BEAM LAMINATE DOUBLE SIDED CONNECTING GALLERY PANEL, CONNECTOR ENDS





- Attaches to power beam channel.
- To be installed at end of power beam run.
- Finished in thermally fused laminate.
- No connection both sides.
- Locking connection both sides.
- Laminate Gallery Panel height is inclusive of panel glides extended to their full height.
- If wood grain is selected, grain runs horizontally.
- Power beam channel and bottom connecting bracket to be ordered separately.

	DESCRIPTION	PRODUCT CODE	LIST PRICE LP	DIMENSIONS/INCHES		
				H	W	D
	Laminate Double Sided Connecting Gallery Panel - Finished Ends - 42" High	EVPBLEPDS4251	741	42	51	1
		EVPBLEPDS4263	963	42	63	1
		EVPBLEPDS4275	1188	42	75	1
	Laminate Double Sided Connecting Gallery Panel - Finished Ends - 48" High	EVPBLEPDS4851	807	48	51	1
		EVPBLEPDS4863	1069	48	63	1
		EVPBLEPDS4875	1299	48	75	1
	Laminate Double Sided Connecting Gallery Panel - Finished Ends - 52" High	EVPBLEPDS5451	937	54	51	1
		EVPBLEPDS5463	1224	54	63	1
		EVPBLEPDS5475	1415	54	75	1

GALLERY PANELS

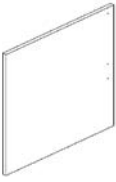
EVPBLEPSSNC- POWER BEAM LAMINATE SINGLE SIDED GALLERY PANEL, FINISHED ENDS



- Attaches to power beam channel.
- To be installed at end of power beam run on one side.
- Finished in thermally fused laminate.
- No connection both sides.
- Laminate Gallery Panel height is inclusive of panel glides extended to their full height.
- If wood grain is selected, grain runs horizontally.
- Power beam channel and bottom connecting bracket to be ordered separately.

	DESCRIPTION	PRODUCT CODE	LIST PRICE LP	DIMENSIONS/INCHES		
				H	W	D
	Laminate Single Sided Connecting Gallery Panel - Finished Ends - Left - 42" High	EVPBLEPSSL4227NC	482	42	27	1
		EVPBLEPSSL4233NC	538	42	33	1
		EVPBLEPSSL4239NC	604	42	39	1
		EVPBLEPSSL4245NC	692	42	45	1
		EVPBLEPSSL4251NC	741	42	51	1
	Laminate Single Sided Connecting Gallery Panel - Finished Ends - Left - 48" High	EVPBLEPSSL4827NC	527	48	27	1
		EVPBLEPSSL4833NC	598	48	33	1
		EVPBLEPSSL4839NC	669	48	39	1
		EVPBLEPSSL4845NC	741	48	45	1
		EVPBLEPSSL4851NC	839	48	51	1
	Laminate Single Sided Connecting Gallery Panel - Finished Ends - Left - 54" High	EVPBLEPSSL5427NC	579	54	27	1
		EVPBLEPSSL5433NC	662	54	33	1
		EVPBLEPSSL5439NC	754	54	39	1
		EVPBLEPSSL5445NC	882	54	45	1
		EVPBLEPSSL5451NC	937	54	51	1
	Laminate Single Sided Connecting Gallery Panel - Finished Ends -Right - 42" High	EVPBLEPSSR4227NC	482	42	27	1
		EVPBLEPSSR4233NC	538	42	33	1
		EVPBLEPSSR4239NC	604	42	39	1
		EVPBLEPSSR4245NC	692	42	45	1
		EVPBLEPSSR4251NC	741	42	51	1
	Laminate Single Sided Connecting Gallery Panel - Finished Ends -Right - 48" High	EVPBLEPSSR4827NC	527	48	27	1
		EVPBLEPSSR4833NC	598	48	33	1
		EVPBLEPSSR4839NC	669	48	39	1
		EVPBLEPSSR4845NC	741	48	45	1
		EVPBLEPSSR4851NC	839	48	51	1
	Laminate Single Sided Connecting Gallery Panel - Finished Ends - Right - 54" High	EVPBLEPSSR5427NC	579	54	27	1
		EVPBLEPSSR5433NC	662	54	33	1
		EVPBLEPSSR5439NC	754	54	39	1
		EVPBLEPSSR5445NC	882	54	45	1
		EVPBLEPSSR5451NC	937	54	51	1

GALLERY PANELS

EVPBLEPSS - POWER BEAM LAMINATE SINGLE SIDED GALLERY PANEL, CONNECTOR ENDS

- Attaches to power beam channel.
- To be installed at end of power beam run on one side.
- Finished in thermally fused laminate.
- Locking connection both sides.
- Laminate Gallery Panel height is inclusive of panel glides extended to their full height.
- If wood grain is selected, grain runs horizontally.
- Power beam channel and bottom connecting bracket to be ordered separately.

	DESCRIPTION	PRODUCT CODE	LIST PRICE	DIMENSIONS/INCHES		
			LP	H	W	D
	Laminate Single Sided Connecting Gallery Panel Connector Ends - Left - 42" High	EVPBLEPSSL4227	482	42	27	1
		EVPBLEPSSL4233	538	42	33	1
		EVPBLEPSSL4239	604	42	39	1
		EVPBLEPSSL4245	692	42	45	1
		EVPBLEPSSL4251	741	42	51	1
	Laminate Single Sided Connecting Gallery Panel Connector Ends - Left - 48" High	EVPBLEPSSL4827	527	48	27	1
		EVPBLEPSSL4833	598	48	33	1
		EVPBLEPSSL4839	669	48	39	1
		EVPBLEPSSL4845	741	48	45	1
		EVPBLEPSSL4851	839	48	51	1
	Laminate Single Sided Connecting Gallery Panel Connector Ends - Left - 54" High	EVPBLEPSSL5427	579	54	27	1
		EVPBLEPSSL5433	662	54	33	1
		EVPBLEPSSL5439	754	54	39	1
		EVPBLEPSSL5445	882	54	45	1
		EVPBLEPSSL5451	937	54	51	1
	Laminate Single Sided Connecting Gallery Panel Connector Ends -Right - 42" High	EVPBLEPSSR4227	482	42	27	1
		EVPBLEPSSR4233	538	42	33	1
		EVPBLEPSSR4239	604	42	39	1
		EVPBLEPSSR4245	692	42	45	1
		EVPBLEPSSR4251	741	42	51	1
	Laminate Single Sided Connecting Gallery Panel Connector Ends -Right - 48" High	EVPBLEPSSR4827	527	48	27	1
		EVPBLEPSSR4833	741	48	33	1
		EVPBLEPSSR4839	669	48	39	1
		EVPBLEPSSR4845	741	48	45	1
		EVPBLEPSSR4851	839	48	51	1
	Laminate Single Sided Connecting Gallery Panel Connector Ends - Right - 54" High	EVPBLEPSSR5427	579	54	27	1
		EVPBLEPSSR5433	662	54	33	1
		EVPBLEPSSR5439	754	54	39	1
		EVPBLEPSSR5445	882	54	45	1
		EVPBLEPSSR5451	937	54	51	1

GALLERY PANELS

EVPBLEPDCNC - POWER BEAM LAMINATE DOUBLE SIDED MIDDLE GALLERY PANEL, 24" ELECTRICAL CUTOUT, FINISHED ENDS

- Attaches to power beam channel.
- To be installed in middle between two power beam in straight run.
- Cut out for electric at 24" power beam height
- Finished in thermally fused laminate.
- No connection both sides.
- Laminate Gallery Panel height is inclusive of panel glides extended to their full height.
- If wood grain is selected, grain runs horizontally.
- Power beam channel and bottom connecting bracket to be ordered separately.

	DESCRIPTION	PRODUCT CODE	LIST PRICE LP	DIMENSIONS/INCHES		
				H	W	D
	Laminate Double Sided Middle Gallery Panel - 24" Electrical Cutout - 42" High	EVPBLEPDC4251NC	741	42	51	1
		EVPBLEPDC4263NC	963	42	63	1
		EVPBLEPDC4275NC	1188	42	75	1
	Laminate Double Sided Middle Gallery Panel - 24" Electrical Cutout - 48" High	EVPBLEPDC4851NC	807	48	51	1
		EVPBLEPDC4863NC	1069	48	63	1
		EVPBLEPDC4875NC	1299	48	75	1
	Laminate Double Sided Middle Gallery Panel - 24" Electrical Cutout - 54" High	EVPBLEPDC5451NC	937	54	51	1
		EVPBLEPDC5463NC	1224	54	63	1
		EVPBLEPDC5475NC	1415	54	75	1

EVPBLEPDBNC - POWER BEAM LAMINATE DOUBLE SIDED MIDDLE GALLERY PANEL, 30" ELECTRICAL CUTOUT, FINISHED ENDS

- Attaches to power beam channel.
- To be installed in middle between two power beam in straight run.
- Cut out for electric at 30" power beam height
- Finished in thermally fused laminate.
- No connection both sides.
- Laminate Gallery Panel height is inclusive of panel glides extended to their full height.
- If wood grain is selected, grain runs horizontally.
- Power beam channel and bottom connecting bracket to be ordered separately.

	DESCRIPTION	PRODUCT CODE	LIST PRICE LP	DIMENSIONS/INCHES		
				H	W	D
	Laminate Double Sided Middle Gallery Panel - 30" Electrical Cutout - 42" High	EVPBLEPDC4251BNC	741	42	51	1
		EVPBLEPDC4263BNC	963	42	63	1
		EVPBLEPDC4275BNC	1188	42	75	1
	Laminate Double Sided Middle Gallery Panel - 30" Electrical Cutout - 48" High	EVPBLEPDC4851BNC	807	48	51	1
		EVPBLEPDC4863BNC	1069	48	63	1
		EVPBLEPDC4875BNC	1299	48	75	1
	Laminate Double Sided Middle Gallery Panel - 30" Electrical Cutout - 54" High	EVPBLEPDC5451BNC	937	54	51	1
		EVPBLEPDC5463BNC	1224	54	63	1
		EVPBLEPDC5475BNC	1415	54	75	1

GALLERY PANELS

EVPBLEPDCNC - POWER BEAM LAMINATE DOUBLE SIDED MIDDLE GALLERY PANEL, 36" ELECTRICAL CUTOUT, FINISHED ENDS

- Attaches to power beam channel.
- To be installed in middle between two power beam in straight run.
- Cut out for electric at 36" power beam height
- Finished in thermally fused laminate.
- No connection both sides.
- Laminate Gallery Panel height is inclusive of panel glides extended to their full height.
- If wood grain is selected, grain runs horizontally.
- Power beam channel and bottom connecting bracket to be ordered separately.

	DESCRIPTION	PRODUCT CODE	LIST PRICE LP	DIMENSIONS/INCHES		
				H	W	D
	Laminate Double Sided Middle Gallery Panel - 36" Electrical Cutout - 42" High	EVPBLEPDC4251CNC	741	42	51	1
		EVPBLEPDC4263CNC	963	42	63	1
		EVPBLEPDC4275CNC	1188	42	75	1
	Laminate Double Sided Middle Gallery Panel - 36" Electrical Cutout - 48" High	EVPBLEPDC4851CNC	807	48	51	1
		EVPBLEPDC4863CNC	1069	48	63	1
		EVPBLEPDC4875CNC	1299	48	75	1
	Laminate Double Sided Middle Gallery Panel - 36" Electrical Cutout - 54" High	EVPBLEPDC5451CNC	937	54	51	1
		EVPBLEPDC5463CNC	1224	54	63	1
		EVPBLEPDC5475CNC	1415	54	75	1

GALLERY PANELS

EVPBLEPDC - POWER BEAM LAMINATE DOUBLE SIDED MIDDLE CONNECTING GALLERY PANEL, 24"H ELECTRICAL CUTOUT

- Attaches to power beam channel.
- To be installed in middle between two power beams in straight run.
- Cut out for electric at 24" power beam height.
- Finished in thermally fused laminate.
- No connection both sides.
- Laminate Gallery Panel height is inclusive of panel glides extended to their full height.
- If wood grain is selected, grain runs horizontally.
- Power beam channel and bottom connecting bracket to be ordered separately.

	DESCRIPTION	PRODUCT CODE	LIST PRICE LP	DIMENSIONS/INCHES		
				H	W	D
	Laminate Double Sided Middle Connecting Gallery Panel - Electrical Cutout - 42" High	EVPBLEPDC4251	741	42	51	1
		EVPBLEPDC4263	963	42	63	1
		EVPBLEPDC4275	1188	42	75	1
	Laminate Double Sided Middle Connecting Gallery Panel - Electrical Cutout - 48" High	EVPBLEPDC4851	807	48	51	1
		EVPBLEPDC4863	1069	48	63	1
		EVPBLEPDC4875	1299	48	75	1
	Laminate Double Sided Middle Connecting Gallery Panel - Electrical Cutout - 54" High	EVPBLEPDC5451	937	54	51	1
		EVPBLEPDC5463	1224	54	63	1
		EVPBLEPDC5475	1415	54	75	1

EVPBLEPDC - POWER BEAM LAMINATE DOUBLE SIDED MIDDLE CONNECTING GALLERY PANEL, 30"H ELECTRICAL CUTOUT

- Attaches to power beam channel.
- To be installed in middle between two power beams in straight run.
- Cut out for electric at 30" power beam height
- Finished in thermally fused laminate.
- Locking connection both sides.
- Laminate Gallery Panel height is inclusive of panel glides extended to their full height.
- If wood grain is selected, grain runs horizontally.
- Power beam channel and bottom connecting bracket to be ordered separately.

	DESCRIPTION	PRODUCT CODE	LIST PRICE LP	DIMENSIONS/INCHES		
				H	W	D
	Laminate Double Sided Middle Connecting Gallery Panel - 30" Electrical Cutout - 42" High	EVPBLEPDC4251B	741	42	51	1
		EVPBLEPDC4263B	963	42	63	1
		EVPBLEPDC4275B	1188	42	75	1
	Laminate Double Sided Middle Connecting Gallery Panel - 30" Electrical Cutout - 48" High	EVPBLEPDC4851B	807	48	51	1
		EVPBLEPDC4863B	1069	48	63	1
		EVPBLEPDC4875B	1299	48	75	1
	Laminate Double Sided Middle Connecting Gallery Panel - 30" Electrical Cutout - 54" High	EVPBLEPDC5451B	937	54	51	1
		EVPBLEPDC5463B	1224	54	63	1
		EVPBLEPDC5475B	1415	54	75	1

GALLERY PANELS

EVPBLEPDC - POWER BEAM LAMINATE DOUBLE SIDED MIDDLE CONNECTING GALLERY PANEL, 36"H ELECTRICAL CUTOUT

- Attaches to power beam channel.
- To be installed in middle between two power beams in straight run.
- Cut out for electric at 36" power beam height
- Finished in thermally fused laminate.
- Locking connection both sides.
- Laminate Gallery Panel height is inclusive of panel glides extended to their full height.
- If wood grain is selected, grain runs horizontally.
- Power beam channel and bottom connecting bracket to be ordered separately.

	DESCRIPTION	PRODUCT CODE	LIST PRICE LP	DIMENSIONS/INCHES		
				H	W	D
	Laminate Double Sided Middle Connecting	EVPBLEPDC4251C	741	42	51	1
	Gallery Panel - 30" Electrical Cutout - 42" High	EVPBLEPDC4263C	963	42	63	1
		EVPBLEPDC4275C	1188	42	75	1
	Laminate Double Sided Middle Connecting	EVPBLEPDC4851C	807	48	51	1
	Gallery Panel - 30" Electrical Cutout - 48" High	EVPBLEPDC4863C	1069	48	63	1
		EVPBLEPDC4875C	1299	48	75	1
	Laminate Double Sided Middle Connecting	EVPBLEPDC5451C	937	54	51	1
	Gallery Panel - 30" Electrical Cutout - 54" High	EVPBLEPDC5463C	1224	54	63	1
		EVPBLEPDC5475C	1415	54	75	1

EVPBLEPSCNC - POWER BEAM LAMINATE SINGLE SIDED MIDDLE GALLERY PANEL, FINISHED ENDS, 24"H ELECTRICAL CUTOUT

- Attaches to power beam channel.
- To be installed in middle between two power beam in straight run on one side.
- Cut out for electric at 24" power beam height.
- Finished in thermally fused laminate.
- No connection both sides.
- Laminate Gallery Panel height is inclusive of panel glides extended to their full height.
- If wood grain is selected, grain runs horizontally.
- Power beam channel and bottom connecting bracket to be ordered separately.

	DESCRIPTION	PRODUCT CODE	LIST PRICE LP	DIMENSIONS/INCHES		
				H	W	D
	Laminate Single Sided Middle Gallery	EVPBLEPSC4227NC	482	42	27	1
	Panel - Finished Ends - 42" High	EVPBLEPSC4233NC	538	42	33	1
		EVPBLEPSC4239NC	604	42	39	1
		EVPBLEPSC4245NC	692	42	45	1
		EVPBLEPSC4251NC	741	42	51	1
	Laminate Single Sided Middle Gallery	EVPBLEPSC4827NC	527	48	27	1
	Panel - Finished Ends - 48" High	EVPBLEPSC4833NC	598	48	33	1
		EVPBLEPSC4839NC	669	48	39	1
		EVPBLEPSC4845NC	741	48	45	1
		EVPBLEPSC4851NC	839	48	51	1
	Laminate Single Sided Middle Gallery	EVPBLEPSC5427NC	579	54	27	1
	Panel - Finished Ends - 54" High	EVPBLEPSC5433NC	662	54	33	1
		EVPBLEPSC5439NC	754	54	39	1
		EVPBLEPSC5445NC	741	54	45	1
		EVPBLEPSC5451NC	937	54	51	1

GALLERY PANELS

EEVPBLEPSCNC - POWER BEAM LAMINATE SINGLE SIDED MIDDLE GALLERY PANEL, FINISHED ENDS, 30" H ELECTRICAL CUTOUT

- Attaches to power beam channel.
- To be installed in middle between two power beam in straight run on one side.
- Cut out for electric at 30" power beam height
- Finished in thermally fused laminate.
- No connection both sides.
- Laminate Gallery Panel height is inclusive of panel glides extended to their full height.
- If wood grain is selected, grain runs horizontally.
- Power beam channel and bottom connecting bracket to be ordered separately.

	DESCRIPTION	PRODUCT CODE	LIST PRICE LP	DIMENSIONS/INCHES		
				H	W	D
	Laminate Single Sided Middle Gallery Panel - Finished Ends - 42" High	EVPBLEPSC4227BNC	482	42	27	1
		EVPBLEPSC4233BNC	538	42	33	1
		EVPBLEPSC4239BNC	604	42	39	1
		EVPBLEPSC4245BNC	692	42	45	1
		EVPBLEPSC4251BNC	741	42	51	1
	Laminate Single Sided Middle Gallery Panel - Finished Ends - 48" High	EVPBLEPSC4827BNC	527	48	27	1
		EVPBLEPSC4833BNC	598	48	33	1
		EVPBLEPSC4839BNC	669	48	39	1
		EVPBLEPSC4845BNC	741	48	45	1
		EVPBLEPSC4851BNC	839	48	51	1
	Laminate Single Sided Middle Gallery Panel - Finished Ends - 54" High	EVPBLEPSC5427BNC	579	54	27	1
		EVPBLEPSC5433BNC	662	54	33	1
		EVPBLEPSC5439BNC	754	54	39	1
		EVPBLEPSC5445BNC	882	54	45	1
		EVPBLEPSC5451BNC	937	54	51	1

GALLERY PANELS

EVPBLEPSCNC - POWER BEAM LAMINATE SINGLE SIDED MIDDLE GALLERY PANEL, FINISHED ENDS, 36"H ELECTRICAL CUTOUT

- Attaches to power beam channel.
- To be installed in middle between two power beam in straight run on one side.
- Cut out for electric at 36" power beam height
- Finished in thermally fused laminate.
- No connection both sides.
- Laminate Gallery Panel height is inclusive of panel glides extended to their full height.
- If wood grain is selected, grain runs horizontally.
- Power beam channel and bottom connecting bracket to be ordered separately.

	DESCRIPTION	PRODUCT CODE	LIST PRICE LP	DIMENSIONS/INCHES		
				H	W	D
	Laminate Single Sided Middle Gallery Panel - Finished Ends - 42" High	EVPBLEPSC4227CNC	482	42	27	1
		EVPBLEPSC4233CNC	538	42	33	1
		EVPBLEPSC4239CNC	604	42	39	1
		EVPBLEPSC4245CNC	692	42	45	1
		EVPBLEPSC4251CNC	741	42	51	1
	Laminate Single Sided Middle Gallery Panel - Finished Ends - 48" High	EVPBLEPSC4827CNC	527	48	27	1
		EVPBLEPSC4833CNC	598	48	33	1
		EVPBLEPSC4839CNC	669	48	39	1
		EVPBLEPSC4845CNC	741	48	45	1
		EVPBLEPSC4851CNC	839	48	51	1
	Laminate Single Sided Middle Gallery Panel - Finished Ends - 54" High	EVPBLEPSC5427CNC	579	54	27	1
		EVPBLEPSC5433CNC	662	54	33	1
		EVPBLEPSC5439CNC	754	54	39	1
		EVPBLEPSC5445CNC	882	54	45	1
		EVPBLEPSC5451CNC	937	54	51	1

GALLERY PANELS

EVPBLEPSC - POWER BEAM LAMINATE SINGLE SIDED MIDDLE CONNECTING GALLERY PANEL, 24"H ELECTRICAL CUTOUT

- Attaches to power beam channel.
- To be installed in middle between two power beam in straight run on one side.
- Cut out for electrics at 24" power beam height
- Finished in thermally fused laminate.
- Locking connection one side.
- Laminate Gallery Panel height is inclusive of panel glides extended to their full height.
- If wood grain is selected, grain runs horizontally.
- Power beam channel and bottom connecting bracket to be ordered separately.

	DESCRIPTION	PRODUCT CODE	LIST PRICE LP	DIMENSIONS/INCHES		
				H	W	D
	Laminate Single Sided Connecting Gallery Panel - 24" Electrical Cutout - 42" High	EVPBLEPSC4227	482	42	27	1
		EVPBLEPSC4233	538	42	33	1
		EVPBLEPSC4239	604	42	39	1
		EVPBLEPSC4245	692	42	45	1
		EVPBLEPSC4251	741	42	51	1
	Laminate Single Sided Connecting Gallery Panel - 24" Electrical Cutout - 48" High	EVPBLEPSC4827	527	48	27	1
		EVPBLEPSC4833	598	48	33	1
		EVPBLEPSC4839	669	48	39	1
		EVPBLEPSC4845	741	48	45	1
		EVPBLEPSC4851	839	48	51	1
	Laminate Single Sided Connecting Gallery Panel - 24" Electrical Cutout - 54" High	EVPBLEPSC5427	579	54	27	1
		EVPBLEPSC5433	662	54	33	1
		EVPBLEPSC5439	754	54	39	1
		EVPBLEPSC5445	882	54	45	1
		EVPBLEPSC5451	937	54	51	1

EVPBLEPSC - POWER BEAM LAMINATE SINGLE SIDED MIDDLE CONNECTING GALLERY PANEL, 30"H ELECTRICAL CUTOUT

- Attaches to power beam channel.
- To be installed in middle between two power beam in straight run on one side.
- Cut out for electrics at 30" power beam height.
- Finished in thermally fused laminate.
- Locking connection on one side.
- Laminate Gallery Panel height is inclusive of panel glides extended to their full height.
- If wood grain is selected, grain runs horizontally.
- Power beam channel and bottom connecting bracket to be ordered separately.

	DESCRIPTION	PRODUCT CODE	LIST PRICE LP	DIMENSIONS/INCHES		
				H	W	D
	Laminate Single Sided Connecting Gallery Panel - 30" Electrical Cutout - 42" High	EVPBLEPSC4227B	482	42	27	1
		EVPBLEPSC4233B	538	42	33	1
		EVPBLEPSC4239B	604	42	39	1
		EVPBLEPSC4245B	692	42	45	1
		EVPBLEPSC4251B	741	42	51	1
	Laminate Single Sided Connecting Gallery Panel - 30" Electrical Cutout - 48" High	EVPBLEPSC4827B	527	48	27	1
		EVPBLEPSC4833B	598	48	33	1
		EVPBLEPSC4839B	669	48	39	1
		EVPBLEPSC4845B	741	48	45	1
		EVPBLEPSC4851B	839	48	51	1
	Laminate Single Sided Connecting Gallery Panel - 30" Electrical Cutout - 54" High	EVPBLEPSC5427B	579	54	27	1
		EVPBLEPSC5433B	662	54	33	1
		EVPBLEPSC5439B	754	54	39	1
		EVPBLEPSC5445B	882	54	45	1
		EVPBLEPSC5451B	937	54	51	1

GALLERY PANELS

EVPBLEPSC - POWER BEAM LAMINATE SINGLE SIDED MIDDLE CONNECTING GALLERY PANEL, 36" H ELECTRICAL CUTOUT



- Attaches to power beam channel.
- To be installed in middle between two power beam in straight run on one side.
- Cut out for electric at 36" power beam height
- Finished in thermally fused laminate.
- Locking connection on one side.
- Laminate Gallery Panel height is inclusive of panel glides extended to their full height.
- If wood grain is selected, grain runs horizontally.
- Power beam channel and bottom connecting bracket to be ordered separately.

	DESCRIPTION	PRODUCT CODE	LIST PRICE LP	DIMENSIONS/INCHES		
				H	W	D
	Laminate Single Sided Connecting Gallery Panel - 36" Electrical Cutout - 42" High	EVPBLEPSC4227C	482	42	27	1
		EVPBLEPSC4233C	538	42	33	1
		EVPBLEPSC4239C	604	42	39	1
		EVPBLEPSC4245C	692	42	45	1
		EVPBLEPSC4251C	741	42	51	1
	Laminate Single Sided Connecting Gallery Panel - 36" Electrical Cutout - 48" High	EVPBLEPSC4827C	527	48	27	1
		EVPBLEPSC4833C	598	48	33	1
		EVPBLEPSC4839C	669	48	39	1
		EVPBLEPSC4845C	741	48	45	1
		EVPBLEPSC4851C	839	48	51	1
	Laminate Single Sided Connecting Gallery Panel - 36" Electrical Cutout - 54" High	EVPBLEPSC5427C	579	54	27	1
		EVPBLEPSC5433C	662	54	33	1
		EVPBLEPSC5439C	754	54	39	1
		EVPBLEPSC5445C	882	54	45	1
		EVPBLEPSC5451C	937	54	51	1

GALLERY PANELS

EVLPXPMNC - LAMINATE GALLERY EXTENSION PANEL, FINISHED END



- Locking connection on one side, no connection at end.
- Finished in thermally fused laminate.
- Laminate Gallery Extension Panel height is inclusive of panel glides extended to their full height.
- If wood grain is selected, grain runs horizontally.
- Bottom connecting brackets to be ordered separately.

	DESCRIPTION	PRODUCT CODE	LIST PRICE LP	DIMENSIONS/INCHES		
				H	W	D
	Laminate Gallery Extension Panel	EVLPXPM4224NC	395	42	24	1
	Finished End - 42" High	EVLPXPM4230NC	482	42	30	1
		EVLPXPM4236NC	538	42	36	1
		EVLPXPM4242NC	603	42	42	1
		EVLPXPM4248NC	691	42	48	1
	Laminate Gallery Extension Panel	EVLPXPM4824NC	454	48	24	1
	Finished End - 48" High	EVLPXPM4830NC	527	48	30	1
		EVLPXPM4836NC	598	48	36	1
		EVLPXPM4842NC	669	48	42	1
		EVLPXPM4848NC	741	48	48	1
	Laminate Gallery Extension Panel	EVLPXPM5424NC	495	54	24	1
	Finished End - 54" High	EVLPXPM5430NC	579	54	30	1
		EVLPXPM5436NC	662	54	36	1
		EVLPXPM5442NC	754	54	42	1
		EVLPXPM5448NC	882	54	48	1
	Laminate Gallery Extension Panel	EVLPXPMR4224NC	395	42	24	1
	Finished End - 42" High	EVLPXPMR4230NC	482	42	30	1
		EVLPXPMR4236NC	538	42	36	1
		EVLPXPMR4242NC	603	42	42	1
		EVLPXPMR4248NC	691	42	48	1
	Laminate Gallery Extension Panel	EVLPXPMR4824NC	454	48	24	1
	Finished End - 48" High	EVLPXPMR4830NC	527	48	30	1
		EVLPXPMR4836NC	598	48	36	1
		EVLPXPMR4842NC	669	48	42	1
		EVLPXPMR4848NC	741	48	48	1
	Laminate Gallery Extension Panel	EVLPXPMR5424NC	495	54	24	1
	Finished End - 54" High	EVLPXPMR5430NC	579	54	30	1
		EVLPXPMR5436NC	662	54	36	1
		EVLPXPMR5442NC	754	54	42	1
		EVLPXPMR5448NC	882	54	48	1

GALLERY PANELS

EVLXPM - LAMINATE GALLERY STRAIGHT EXTENSION PANEL, CONNECTOR ENDS



- Locking connection both sides.
- Finished in thermally fused laminate.
- Laminate Gallery Panel height is inclusive of panel glides extended to their full height.
- If wood grain is selected, grain runs horizontally.
- Bottom connecting brackets to be ordered separately.

	DESCRIPTION	PRODUCT CODE	LIST PRICE LP	DIMENSIONS/INCHES		
				H	W	D
	Laminate Gallery Straight Extension	EVLXPML4224	395	42	24	1
	Panel - Connector Ends - Left - 42" High	EVLXPML4230	482	42	30	1
		EVLXPML4236	538	42	36	1
		EVLXPML4242	603	42	42	1
		EVLXPML4248	691	42	48	1
	Laminate Gallery Straight Extension	EVLXPML4824	454	48	24	1
	Panel - Connector Ends - Left - 48" High	EVLXPML4830	527	48	30	1
		EVLXPML4836	741	48	36	1
		EVLXPML4842	669	48	42	1
		EVLXPML4848	741	48	48	1
	Laminate Gallery Straight Extension	EVLXPML5424	495	54	24	1
	Panel - Connector Ends - Left - 54" High	EVLXPML5430	579	54	30	1
		EVLXPML5436	662	54	36	1
		EVLXPML5442	754	54	42	1
		EVLXPML5448	882	54	48	1
	Laminate Gallery Straight Extension	EVLXPMR4224	395	42	24	1
	Panel - Connector Ends - Right - 42" High	EVLXPMR4230	482	42	30	1
		EVLXPMR4236	538	42	36	1
		EVLXPMR4242	603	42	42	1
		EVLXPMR4248	691	42	48	1
	Laminate Gallery Straight Extension	EVLXPMR4824	454	48	24	1
	Panel - Connector Ends - Right - 48" High	EVLXPMR4830	527	48	30	1
		EVLXPMR4836	598	48	36	1
		EVLXPMR4842	669	48	42	1
		EVLXPMR4848	741	48	48	1
	Laminate Gallery Straight Extension	EVLXPMR5424	495	54	24	1
	Panel - Connector Ends - Right - 54" High	EVLXPMR5430	579	54	30	1
		EVLXPMR5436	662	54	36	1
		EVLXPMR5442	754	54	42	1
		EVLXPMR5448	882	54	48	1

GALLERY PANELS

EV2LXP - LAMINATE GALLERY TWO-WAY EXTENSION PANEL, FINISHED ENDS

- Panel connects at 90 degree with extension panel.
- Finished in thermally fused laminate.
- Laminate Gallery Extension Panel height is inclusive of panel glides extended to their full height.
- If wood grain is selected, grain runs horizontally.
- Corner connecting brackets to be ordered separately.

	DESCRIPTION	PRODUCT CODE	LIST PRICE LP	DIMENSIONS/INCHES		
				H	W	D
	Laminate Gallery Two-Way Extension Panel - Finished Ends - Left - 42" High	EV2LXPL4225	397	42	25	1
		EV2LXPL4231	482	42	31	1
		EV2LXPL4237	538	42	37	1
		EV2LXPL4243	604	42	43	1
		EV2LXPL4249	692	42	49	1
	Laminate Gallery Two-Way Extension Panel - Finished Ends - Left - 48" High	EV2LXPL4825	454	48	25	1
		EV2LXPL4831	527	48	31	1
		EV2LXPL4837	598	48	37	1
		EV2LXPL4843	669	48	43	1
		EV2LXPL4849	741	48	49	1
	Laminate Gallery Two-Way Extension Panel - Finished Ends - Left - 54" High	EV2LXPL5425	532	54	25	1
		EV2LXPL5431	608	54	31	1
		EV2LXPL5437	683	54	37	1
		EV2LXPL5443	831	54	43	1
		EV2LXPL5449	937	54	49	1
	Laminate Gallery Two-Way Extension Panel - Finished Ends - Right - 42" High	EV2LXPR4225	397	42	25	1
		EV2LXPR4231	482	42	33	1
		EV2LXPR4237	538	42	37	1
		EV2LXPR4243	604	42	43	1
		EV2LXPR4249	692	42	49	1
	Laminate Gallery Two-Way Extension Panel - Finished Ends - Right - 48" High	EV2LXPR4825	454	48	25	1
		EV2LXPR4831	527	48	33	1
		EV2LXPR4837	598	48	37	1
		EV2LXPR4843	669	48	43	1
		EV2LXPR4849	741	48	49	1
	Laminate Gallery Two-Way Extension Panel - Finished Ends - Right - 54" High	EV2LXPR5425	532	54	25	1
		EV2LXPR5431	608	54	31	1
		EV2LXPR5437	683	54	37	1
		EV2LXPR5443	831	54	43	1
		EV2LXPR5449	937	54	49	1

GALLERY PANELS

EV3LXP - LAMINATE GALLERY THREE-WAY EXTENSION PANEL, FINISHED ENDS

- Panel connects "T" configuration with extension panel.
- Finished in thermally fused laminate.
- Laminate Gallery Extension Panel height is inclusive of panel glides extended to their full height.
- If wood grain is selected, grain runs horizontally.
- Corner connecting brackets to be ordered separately.

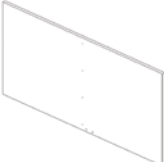
	DESCRIPTION	PRODUCT CODE	LIST PRICE LP	DIMENSIONS/INCHES		
				H	W	D
	Laminate Gallery Three-Way Extension Panel - Finished Ends - Left - 42" High	EV3LXPL4249	741	42	49	1
		EV3LXPL4261	882	42	61	1
		EV3LXPL4273	1027	42	73	1
	Laminate Gallery Three-Way Extension Panel - Finished Ends - Left - 48" High	EV3LXPL4849	839	48	49	1
		EV3LXPL4861	1031	48	61	1
		EV3LXPL4873	1224	48	73	1
	Laminate Gallery Three-Way Extension Panel - Finished Ends - Left - 54" High	EV3LXPL5449	937	54	49	1
		EV3LXPL5461	1224	54	61	1
		EV3LXPL5473	1415	54	73	1
	Laminate Gallery Three-Way Extension Panel - Finished Ends - Left - 42" High	EV3LXPR4249	741	42	49	1
		EV3LXPR4261	882	42	61	1
		EV3LXPR4273	1027	42	73	1
	Laminate Gallery Three-Way Extension Panel - Finished Ends - Left - 48" High	EV3LXPR4849	839	48	49	1
		EV3LXPR4861	1031	48	61	1
		EV3LXPR4873	1224	48	73	1
	Laminate Gallery Three-Way Extension Panel - Finished Ends - Left - 54" High	EV3LXPR5449	937	54	49	1
		EV3LXPR5461	1224	54	61	1
		EV3LXPR5473	1415	54	73	1

GALLERY PANELS

EV4LXP - LAMINATE DOUBLE GALLERY PANEL FOR FOUR-WAY, FINISHED ENDS

- Panel connects "+" configuration with extension panel.
- Finished in thermally fused laminate.
- Laminate Gallery Extension Panel height is inclusive of panel glides extended to their full height.
- If wood grain is selected, grain runs horizontally.
- Corner connecting brackets to be ordered separately

	DESCRIPTION	PRODUCT CODE	LIST PRICE LP	DIMENSIONS/INCHES		
				H	W	D
	Laminate Double Gallery Panel	EV4LXP4249	741	42	49	1
	Four-Way - Finished Ends - 42" High	EV4LXP4261	965	42	61	1
		EV4LXP4273	1188	42	73	1
	Laminate Double Gallery Panel	EV4LXP4849	807	48	49	1
	Four-Way - Finished Ends - 48" High	EV4LXP4861	1069	48	61	1
		EV4LXP4873	1299	48	73	1
	Laminate Double Gallery Panel	EV4LXP5449	937	54	49	1
	Four-Way - Finished Ends - 48" High	EV4LXP5461	1224	54	61	1
		EV4LXP5473	1415	54	73	1

EV4LXPM - LAMINATE GALLERY EXTENSION PANEL FOR FOUR-WAY CONFIGURATION, FINISHED ENDS

- Locking connection on one side only for four way panel.
- Finished in thermally fused laminate.
- Universal to be used on both sides of four way laminate panel.
- Laminate Gallery Extension Panel height is inclusive of panel glides extended to their full height.
- If wood grain is selected, grain runs horizontally.
- Bottom connecting brackets to be ordered separately.

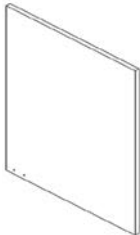
	DESCRIPTION	PRODUCT CODE	LIST PRICE LP	DIMENSIONS/INCHES		
				H	W	D
	Laminate Gallery Extension Panel	EV4LXPM4224	395	42	24	1
	Four-Way - Finished Ends - 42" High	EV4LXPM4230	482	42	30	1
		EV4LXPM4236	538	42	36	1
		EV4LXPM4242	603	42	42	1
		EV4LXPM4248	691	42	58	1
	Laminate Gallery Extension Panel	EV4LXPM4824	454	48	24	1
	Four-Way - Finished Ends - 42" High	EV4LXPM4830	527	48	30	1
		EV4LXPM4836	598	48	36	1
		EV4LXPM4842	669	48	42	1
		EV4LXPM4848	741	48	48	1
	Laminate Gallery Extension Panel	EV4LXPM5424	495	54	24	1
	Four-Way - Finished Ends - 42" High	EV4LXPM5430	579	54	30	1
		EV4LXPM5436	662	54	36	1
		EV4LXPM5442	754	54	42	1
		EV4LXPM5448	882	54	48	1

GALLERY PANELS

EVPBIECH - POWER BEAM CONNECTOR CHANNEL

- One piece channel for power beam and extension module above, attaches to laminate panels with screws.
- Power beam attaches to channel with clamps and extension module attaches above.
- Channel has cut out for power beam electric to run thru laminate panel.
- Note: not stackable. Channel has cut out for power beam electric to run thru laminate panel.

DESCRIPTION	PRODUCT CODE	LIST PRICE LP	DIMENSIONS/INCHES		
			H	W	D
 Connector Channel	EVPBIECH12	55	12	2.875	
	EVPBIECH18	63	18	2.875	
	EVPBIECH24	74	24	2.875	
	EVPBIECH30	81	30	2.875	
	EVPBIECH36	87	36	2.875	

EVHLPBB01 - LAMINATE GALLERY PANEL BOTTOM BRACKET

- Laminate panel bottom bracket connects two laminate end panels at bottom with screws.
- Available in standard paint colors.
- Bracket and screws included.

DESCRIPTION	PRODUCT CODE	LIST PRICE LP	DIMENSIONS/INCHES		
			H	W	D
 Bottom Bracket	EVHLPBB01	51	1.5	8	1

EVHLPB01 - LAMINATE GALLERY PANEL CORNER BRACKET

- Laminate panel corner bottom bracket connects two laminate panels at 90 degree.
- Available in standard paint colors.
- Bracket and screws included.

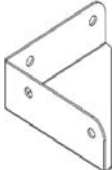
DESCRIPTION	PRODUCT CODE	LIST PRICE LP	DIMENSIONS/INCHES		
			H	W	D
 Corner Bracket	EVHLPB01	50	1.5	4	4

GALLERY PANELS

EVPBGFC - GALLERY PANEL BASE FEED COVER

- Connects to gallery panels, underneath power beam with electrical cutout.
- Includes vertical covers and slotted connector.
- Power beam with electrical cut out to be ordered separately.



DESCRIPTION	PRODUCT CODE	LIST PRICE LP	DIMENSIONS/INCHES		
			H	W	D
Gallery Panel Base Feed Cover	EVPBGFC24	198	24	6	3
	EVPBGFC30	226	30	6	3
	EVPBGFC36	254	36	6	3

EVPBGDP - GALLERY PANEL POWER DATA POST / COMM LAY-IN

- Attaches to Power beam gallery end panel to bring power and/or data cables from ceiling to power beam.
- Three-sided power pole with snap-on fourth side.
- Made of aluminum and can be field cut.
- Accommodates up to 25 CAT 5 cables with electric.
- Accommodates up to 45 CAT 5 cables without electric.
- Standard data post extension used above.
- Standard data post extension to be ordered separately.



DESCRIPTION	PRODUCT CODE	LIST PRICE LP	DIMENSIONS/INCHES		
			H	W	D
Gallery Panel Power Data Post 24" High	EVPBGDP42	173	42	2	
	EVPBGDP48	195	48	2	
	EVPBGDP54	236	54	2	
Gallery Panel Power Data Post 30" High	EVPBGDP42B	173	42	2	
	EVPBGDP48B	195	48	2	
	EVPBGDP54B	236	54	2	
Gallery Panel Power Data Post 36" High	EVPBGDP42C	173	42	2	
	EVPBGDP48C	195	48	2	
	EVPBGDP54C	236	54	2	

GALLERY PANELS

EVPBLEP - LAMINATE END PANEL FOR POWER BEAM

- Connects to a power beam support leg with foot at the end of a run
- Includes brackets to attach to support leg with foot
- Finished in thermally fused laminate. If wood grain is selected, grain runs horizontally
- Laminate End Panel height is inclusive of panel glides extended to their full height
- Laminate end panel must connect to a support leg with foot and will not connect to a support leg with glide
- Must be used with Connectors with T-Leg

DESCRIPTION	PRODUCT CODE	LIST PRICE	DIMENSIONS/INCHES		
			H	W	D
 Laminate End Panel for Power Beam	EVPBLEP2451	411	24	51	1
	EVPBLEP3051	513	30	51	1
	EVPBLEP3651	619	36	51	1
	EVPBLEP4251	907	42	51	1
	EVPBLEP2463	502	24	63	1
	EVPBLEP3063	624	30	63	1
	EVPBLEP3663	742	36	63	1
	EVPBLEP4263	1013	42	63	1

EVPBLEP - LAMINATE END PANEL FOR POWER BEAM, SINGLE LEG

- Attaches to power beam connector with single leg
- For one sided Power beam application
- Includes brackets to attached to leg
- Finished in thermally fused laminate, if wood grain is selected, grain runs horizontally
- Laminate End Panel height is inclusive of panel glides extended to their full height
- EVPBLEPxx30 to be used for 24" deep worksurface
- EVPBLEPxx36 to be used for 30" deep worksurface

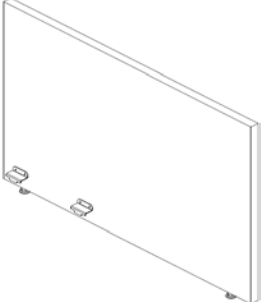
DESCRIPTION	PRODUCT CODE	LIST PRICE	DIMENSIONS/INCHES		
			H	W	D
	EVPBLEP2430	372	24	30	1
	EVPBLEP3030	401	30	30	1
	EVPBLEP3630	430	36	30	1
	EVPBLEP4230	503	42	30	1
	EVPBLEP2436	433	24	36	1
	EVPBLEP3036	448	30	36	1
	EVPBLEP3636	503	36	36	1
	EVPBLEP4236	603	42	36	1

ELECTRICAL

EVE8PD - POWER DISTRIBUTION HOUSING

- Power housing is specified per beam size (e.g. EVE8PD36 is for use in a 36" beam).
- 8 wire, 4 circuits (2+2 configuration).
- Accommodates two duplex receptacles per panel side.

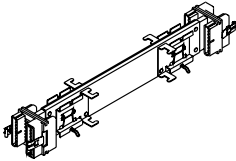
DESCRIPTION	PRODUCT CODE	LIST PRICE	DIMENSIONS/INCHES		
			H	L	D
 Power Distribution Housing	EVE8PD36	248		17 1/2	
	EVE8PD42	254		23 1/2	
	EVE8PD48	275		29 1/2	
	EVE8PD54	277		39 1/4	
	EVE8PD60	278		41 1/2	
	EVE8PD66	288		41 1/2	
	EVE8PD72	304		41 1/2	

EVE8CP - FLEXIBLE MESH JUMPER CABLE

- Used to connect two power distribution housings in a straight run, 90-degree or 120-degree connections.
- 18.5" flexible mesh jumper replaces EVE8CP20 jumper for corner post applications.

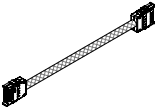
DESCRIPTION	PRODUCT CODE	LIST PRICE	DIMENSIONS/INCHES		
			H	L	D
 Flexible Mesh Jumper Cable	EVE8CP17	135		17 1/2	
	EVE8CP18	167		18 1/2	

EVE8CPXX-H - PASS-THROUGH CABLE

- Flexible metal conduit with wire mesh distributes electrical power through non-powered beams.
- To calculate the length of a Pass-Through Cable, add the widths of the non-powered beam separating the powered panels (panels with distribution housing attached). To this, add 16" (distance from the edge of the panel to the distribution housing x 2).
- Add additional 3" when passing through a post. See the Tips at the beginning of the section for more details.
- Hybrid pass-through cables with wire mesh allows connection at 90 degree post at one end for Evolve panels including Beltline and Power Beam.

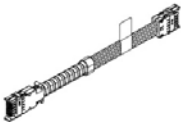
DESCRIPTION	PRODUCT CODE	LIST PRICE	DIMENSIONS/INCHES		
			H	L	D
 Pass-Through Cable	EVE8CP40-H	226		40	
	EVE8CP46-H	234		46	
	EVE8CP52-H	240		52	
	EVE8CP58-H	255		58	
	EVE8CP64-H	266		64	
	EVE8CP70-H	274		70	
	EVE8CP76-H	277		76	
	EVE8CP82-H	288		82	
	EVE8CP88-H	298		88	
	EVE8CP94-H	305		88	
	EVE8CP100-H	315		100	
	EVE8CP106-H	330		106	
	EVE8CP118-H	346		118	
	EVE8CP130-H	380		130	
	EVE8CP142-H	397		142	
	EVE8CP154-H	416		154	
	EVE8CP172-H	447		172	
	EVE8CP190-H	468		190	
	EVE8CP208-H	486		208	

ELECTRICAL

EVE8CP50-H - JUMPER CABLE PANEL TO POWER BEAM

- Jumper cable to connect panel power distribution housing to power beam
- Hybrid jumper cable with metal conduit and with 24" long wire mesh end to be able to plug into power beam
- Panel to Power beam Post with vertical base feed covers to be ordered separately
- Power beam with electrical cut out must be ordered
- 50" long Jumper cable will work with 24", 30" and 36" H Power beam



DESCRIPTION	PRODUCT CODE	LIST PRICE	DIMENSIONS/INCHES		
			H	L	D

Jumper cable Panel to Power Beam	EVE8CP50-H	229		50	
----------------------------------	------------	-----	--	----	--

EVE8CI-1 - "I" CONNECTOR

- Female - Female connector used to connect two Pass-Through Cables
- Connects receptacles for 66" w and 72" w modules when two are required on one end

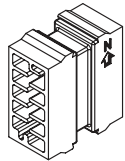

DESCRIPTION	PRODUCT CODE	LIST PRICE	DIMENSIONS/INCHES		
			H	W	D

"I" Connector	EVE8CI-1	101			
---------------	----------	-----	--	--	--

EVE8RD - DUPLEX RECEPTACLE TO CONVERT STANDARD 2 + 2 SYSTEM TO 3 + 1

- Duplex receptacle are rated for 15 Amps
- EVE8RDA-4 = Duplex receptacle A without triangle to be utility circuit
- EVE8RDB-4 = Duplex receptacle B without triangle to be utility circuit
- Up to 6 receptacles per circuit (24 per infeed) not to exude total 15 Amps per circuit
- Standard in black. Available in White or Nevada with upcharge. Add \$3

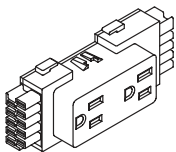

DESCRIPTION	PRODUCT CODE	LIST PRICE	DIMENSIONS/INCHES		
			H	L	D

Duplex Receptacle	EVE8RDA-4	39	2	4 5/8	1 1/4
	EVE8RDB-4	39	2	4 5/8	1 1/4

ELECTRICAL

EVE8RD - DUPLEX RECEPTACLE - 15 AMPS

- Duplex receptacles are rated for 15 Amps.
- EVE8RD1 = Circuit #1 (utility circuit)
- EVE8RD2 = Circuit #2 (utility circuit)
- EVE8RDA = Circuit A (dedicated)
- EVE8RDB = Circuit B (dedicated)

NOTE:

- EVE8RD1 and EVE8RD2 (#1 and #2 share common ground)
- EVE8RDA and EVE8RDB (A and B share common ground)
- Up to 6 receptacles per circuit (24 per infeed), not to exceed total of 15 Amps per circuit.
- Standard in black. Available in White or Nevada with upcharge.

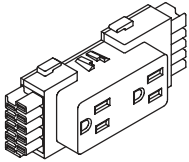
	DESCRIPTION	PRODUCT CODE	LIST PRICE	DIMENSIONS/INCHES		
				H	W	D
	Duplex Receptacle	EVE8RD1	39	2	4 5/8	1 1/4
		EVE8RD2	39	2	4 5/8	1 1/4
		EVE8RDA	39	2	4 5/8	1 1/4
		EVE8RDB	39	2	4 5/8	1 1/4
		EVE8RD1SND	44	2	4 5/8	1 1/4
		EVE8RD2SND	44	2	4 5/8	1 1/4
		EVE8RDASND	44	2	4 5/8	1 1/4
		EVE8RDBSND	44	2	4 5/8	1 1/4
		EVE8RD1WHT	44	2	4 5/8	1 1/4
		EVE8RD2WHT	44	2	4 5/8	1 1/4
		EVE8DAWHT	44	2	4 5/8	1 1/4
		EVE8DBWHT	44	2	4 5/8	1 1/4

EVE8RDxca - CONTROLLED DUPLEX RECEPTACLE

- Meets California Title 24, Federal and LEED certification guidelines
- Allows circuit to be controlled or switched off when utility is not in use.
- Duplex receptacles are rated for 15 Amps.
- EVE8RD1CA = Circuit #1 (utility circuit)
- EVE8RD2CA = Circuit #2 (utility circuit)
- EVE8RDACA = Circuit A (dedicated)
- EVE8RDBCA = Circuit B (dedicated)

NOTE:

- EVE8RD1CA and EVE8RD2CA (#1 and #2 share common ground)
- EVE8RDACA and EVE8RDBCA (A and B share common ground)
- Up to 6 receptacles per circuit (24 per infeed), not to exceed total of 15 Amps per circuit.
- Available in BLK finish only.

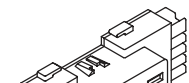
	DESCRIPTION	PRODUCT CODE	LIST PRICE	DIMENSIONS/INCHES		
				H	W	D
	Duplex Receptacle	EVE8RD1CA	42	2	4 5/8	1 1/4
		EVE8RD2CA	42	2	4 5/8	1 1/4
		EVE8RDACA	42	2	4 5/8	1 1/4
		EVE8RDBCA	42	2	4 5/8	1 1/4

ELECTRICAL

EVEUSB01 - USB MODULE

- Includes two USB ports.
- Available in White and Black.

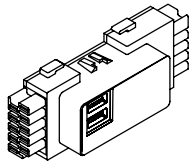

DESCRIPTION	PRODUCT CODE	LIST PRICE	DIMENSIONS/INCHES		
			H	L	D
USB Module - White	EVEUSB01WHT	242	2	4 5/8	1 1/4
USB Module - Black	EVEUSB01BLK	242	2	4 5/8	1 1/4

EVE8FR3PB - POWER ENTRY FOR POWER BEAM

- Snaps in to power distribution housing
- Includes 84" long flexible vinyl conduit
- Includes bracket to attach within vertical infeed cover
- Must be hardwired to source by licensed electrician

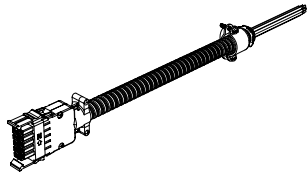

DESCRIPTION	PRODUCT CODE	LIST PRICE	DIMENSIONS/INCHES		
			H	W	D
	EVE8FR3PB	518		84	

EVE8FR3PBD - DOUBLE POWER ENTRY FOR POWER BEAM

- Each power feed entry snaps into separate power distribution housing
- Includes two 84" long flexible vinyl conduit
- Includes double bracket to attach to Vertical base power feed cover leg
- Must be installed in middle between two power beams, one base feed plugs to power beam on opposite side of leg than attached bracket
- Vertical base power feed cover with leg to be ordered separately
- Must be hardwired to source by licensed electrician

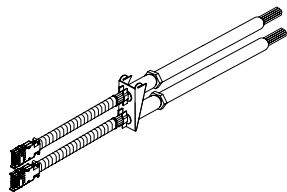

DESCRIPTION	PRODUCT CODE	LIST PRICE	DIMENSIONS/INCHES		
			H	W	D
	EVE8FR3PBD	865		84	

NOTE: Always determine that each individual harness is electrically connected to only one power supply.

EVE8EC - CEILING POWER ENTRY

- Must specify at a 90 or 120 Degree Post
- Post extension specified separate
- Floor plate must be separate on post with ceiling infeed

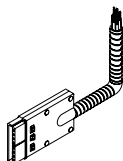

DESCRIPTION	PRODUCT CODE	LIST PRICE	DIMENSIONS/INCHES		
			H	L	D
Ceiling Power Entry	EVE8EC1	304		132	
	EVE8EC2	532		144	
	EVE8EC3	600		180	

ELECTRICAL

EVEENY-2PB - HARDWARE POWER ENTRY BOX - NEW YORK FOR POWER BEAM

- A licensed electrician must provide hard wire connection within the junction box.
- Box attaches vertically with screws to leg between Vertical base feed covers
- Vertical base power feed cover with leg to be ordered separately
- Must be installed in middle between two power beams, plugs to power beam on opposite side of leg than attached box
- For use with Power Beam only

DESCRIPTION	PRODUCT CODE	LIST PRICE	DIMENSIONS/INCHES		
			H	W	D

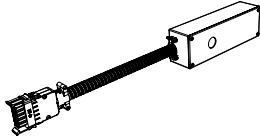

Hardware Power Entry Box - New York	EVEENY2PB	503	3	28	2 1/5
-------------------------------------	-----------	-----	---	----	-------

EVEJBC-1PB - HARDWARE JUNCTION BOX - CHICAGO FOR POWER BEAM

- Can be retrofitted in any size of power beam at the receptacle location.
- Gives access from one side only at each location.
- Customer to supply conduit, wiring, receptacle, and face plate.
- A licensed electrician must provide hardware connection with the junction box.
- 2 per power beam
- For use with Power Beam only

DESCRIPTION	PRODUCT CODE	LIST PRICE	DIMENSIONS/INCHES		
			H	W	D

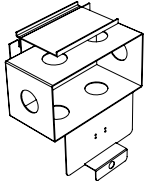

Hardware Junction Box - Chicago	EVEJBC-1PB	116			
---------------------------------	------------	-----	--	--	--

EVDPE - POST EXTENSION DATA/ COMM LAY-IN

- Attaches to the top of post to bring power and/or data cables from ceiling to panel power way
- Three-sided power pole with snap-on fourth side
- Post extension can be open on one side for lay-in or power and/or data cables
- Made of aluminum and can be field cut
- Accommodates up to 25 CAT 5 cables with electric. Accommodates up to 45 CAT 5 cables without electric
- Ceiling infeed installed on one way post with T Leg requires securing post with two Floor mount plates
- Post extension bigger then 82"H is made from two parts

DESCRIPTION	PRODUCT CODE	LIST PRICE	DIMENSIONS/INCHES		
			H	W	D

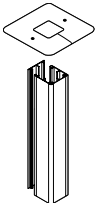

Post Extension Data/Comm Lay-in	EVDPE64	195	64	2	
	EVDPE82	236	84	2	
	EVDPE88	350	88	2	
	EVDPE94	375	94	2	
	EVDPE100	399	100	2	

ELECTRICAL

EVAFMB01 - FLOOR MOUNT PLATE

- Attaches to floor.
- Secures beam to floor.
- Attachment screws are not included.
- Care should be taken to use correct fasteners for type of floor.
- Available in chrome finish only.

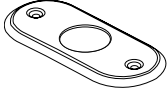
DESCRIPTION	PRODUCT CODE	LIST PRICE	DIMENSIONS/INCHES		
			H	W	D
 Floor Mount Plate	EVAFMB01	98	0.25	5	2.5

EVPBECH34 - E-CHAIN WITH BRACKET

- E-Chain provides cable management from the Power Beam to a height adjustable table
- Includes bracket to attach to bottom of Power Beam
- E-chain provides wire management for all height adjustable table heights
- Available in black only

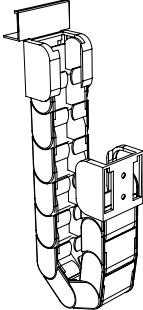
DESCRIPTION	PRODUCT CODE	LIST PRICE	DIMENSIONS/INCHES		
			H	W	D
 E-Chain with Bracket	EVPBECH34	448	41	1	2

EVPBT01 - POWER BEAM TRAY

- Power beam tray provides support for wires
- Can be used with power beam only
- Available in standard and premium paint finishes

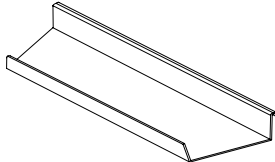
DESCRIPTION	PRODUCT CODE	LIST PRICE	DIMENSIONS/INCHES		
			H	W	D
 Power Beam Tray	EVPBT01	48	12	1.25	3.5

STORAGE

EVAFWMXXP - WIRE MANAGER

- PET Wire manager installed under worksurface
- Including attachment brackets
- Available in standard felt colors

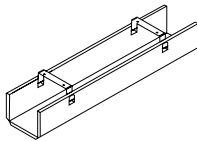
	DESCRIPTION	PRODUCT CODE	LIST PRICE	DIMENSIONS/INCHES		
				H	W	D
	PET Wire Manager	EVAFWM22P	137	3.375	22	4
		EVAFWM28P	158	3.375	28	4
		EVAFWM34P	174	3.375	34	4

EVAFWMXXPL - WIRE MANAGER FOR 90 DEGREE CORNER-LEFT

- PET Wire manager installed under worksurface
- Including attachment brackets
- Available in standard felt colors

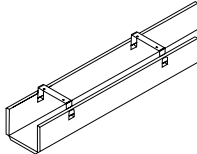
	DESCRIPTION	PRODUCT CODE	LIST PRICE	DIMENSIONS/INCHES		
				H	W	D
	PET Wire Manager	EVAFWM26PL	151	3.375	26	4
	90 Degree Corner - Left	EVAFWM32PL	170	3.375	32	4
		EVAFWM38PL	185	3.375	38	4

EVAFWMXXPR - FELT WIRE MANAGER FOR 90 DEGREE CORNER-RIGHT

- Felt Wire manager installed under worksurface
- Including attachment brackets
- Available in standard felt colors

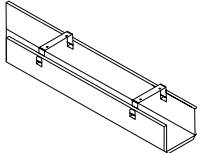
	DESCRIPTION	PRODUCT CODE	LIST PRICE	DIMENSIONS/INCHES		
				H	W	D
	PET Wire Manager	EVAFWM26PR	151	3.375	26	4
	90 Degree Corner - Right	EVAFWM32PR	170	3.375	32	4
		EVAFWM38PR	185	3.375	38	4

STORAGE

EVSDAOH - POWER BEAM DUAL ACCESS OVERHEAD

- Inside dimensions 6.500"high x 13"deep
- Laminate Overhead
- Available in standard Evolve laminate finishes
- Top mount on power beam
- Dual Access Overhead Support Brackets to be ordered separately
- Horizontal tube with trim and power beam legs for storage to be ordered separately
- Power Beam shared storage cabinet must be installed at bottom for stability
- Power beam legs for storage must be used

DESCRIPTION	PRODUCT CODE	LIST PRICE	DIMENSIONS/INCHES		
			H	W	D
Dual Access Overhead	EVSDAOH60	1430	8.5	60	16
	EVSDAOH72	1452	8.6	72	16

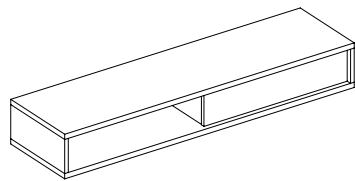

EVPBSCGD - POWER BEAM SHARED STORAGE CABINET WITH SLIDING GLASS DOOR

- Inside dimensions 13"high x 13"deep
- Laminate storage cabinet, available in standard Evolve laminate finishes
- Available in Temperete Frosted Glass only, glass with hole to pull
- Tracks for sliding glass available in Tungsten only
- To be used with 24" H Power beam only
- To be installed under power beam between T legs
- Power Beam Storage cabinet attaches to bottom of power beam with brackets
- For ease of installation, levelers in middle included

DESCRIPTION	PRODUCT CODE	LIST PRICE	DIMENSIONS/INCHES		
			H	W	D
Storage Cabinet with Sliding Glass Right	EVPBSCGDR60	2149	15	58.75	16
	EVPBSCGDR72	2397	15	70.75	16
Storage Cabinet with Sliding Glass Left	EVPBSCGDL60	2149	15	58.75	16
	EVPBSCGDL72	2397	15	70.75	16

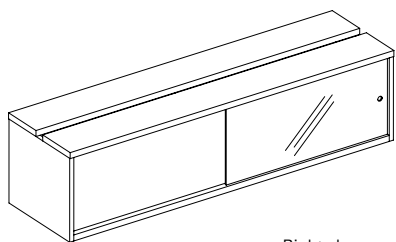

Right shown
(opening on right)

STORAGE

EVPBSCP - POWER BEAM STORAGE CABINET AND CABLE PASS THROUGH

- Inside dimensions 13" high x 13" deep
- Laminate storage cabinet, available in standard Evolve laminate finishes
- To be used with 24" H Power beam only and 60" and 72" widths only
- To be installed under power beam between two T legs
- Power Beam Storage cabinet attaches to bottom of power beam with brackets
- For ease of installation, levelers in middle included
- Cabinet with cable pass through in middle to bring power to power beam above
- Includes metal cover for easy access to wires
- Electrics not included
- Power beam base feed to be ordered separately
- Power beam kit with electrical cut out in middle to be ordered separately (EVPBEPxxKIT see page 7 or EVPBEPxxKIT01 see page 8)

DESCRIPTION	PRODUCT CODE	LIST PRICE	DIMENSIONS/INCHES		
			H	W	D
Storage Cabinet Right	EVPBSCP60	1924	15	58.75	16
	EVPBSCP72	2035	15	70.75	16
Storage Cabinet Left	EVPBSCPL60	1924	15	58.75	16
	EVPBSCPL72	2035	15	70.75	16

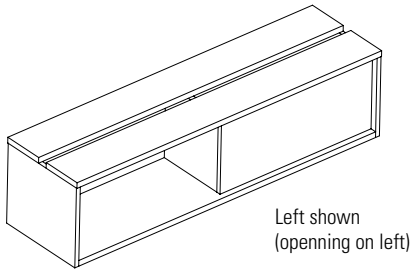

**NOTE: Can not be converted to cabinet with glass door.
To be used with 24" H Power Beam only**

EVPBSCGDP - POWER BEAM STORAGE CABINET WITH SLIDING GLASS DOOR AND CABLE PASS THROUGH

- Inside dimensions 13" high x 13" deep
- Laminate storage cabinet, available in standard Evolve laminate finishes
- Available in Temperete Frosted Glass only, with handle
- Tracks for sliding glass available in Tungsten only
- To be used with 24" H Power beam only and 60" and 72" widths only
- To be installed under power beam between two T legs
- Power Beam Storage cabinet attaches to bottom of power beam with brackets
- For ease of installation, levelers in middle included
- Cabinet with cable pass through in middle to bring power to power beam above
- Includes metal cover for easy access to wires
- Electrics not included
- Power beam base feed to be ordered separately
- Power beam kit with electrical cut out in middle to be ordered separately (EVPBEPxxKIT see page 7 or EVPBEPxxKIT01 see page 8)

DESCRIPTION	PRODUCT CODE	LIST PRICE	DIMENSIONS/INCHES		
			H	W	D
Storage Cabinet with Sliding Glass Right	EVPBSCGDP60	2978	15	58.75	16
	EVPBSCGDP72	3442	15	70.75	16
Storage Cabinet with Sliding Glass Left	EVPBSCGDPL60	2978	15	58.75	16
	EVPBSCGDPL72	3442	15	70.75	16

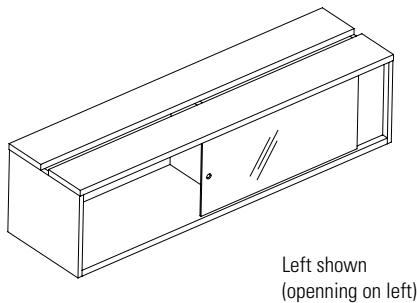

NOTE: To be used with 24" H Power Beam only

STORAGE

VPBL - 36" H POWER BEAM CONNECTOR WITH LEG FOR STORAGE

- Connects 24" H power beams on equal height
- Includes non slotted connector with leg, glides and connecting hardware
- Horizontal tube to be ordered separately
- Must be used with overhead

DESCRIPTION	PRODUCT CODE	LIST PRICE	DIMENSIONS/INCHES		
			H	W	D
Connector with Leg for Storage	EVPBL36S	129	36	18	16

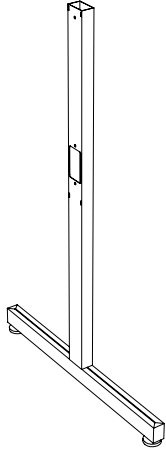

textiles and finishes

Care and Cleaning

The following guide encompasses the Power Beam System line.

The guide was compiled using information from our "raw" material suppliers and is relevant only to our standard offering finishes and textiles.

FABRICS

To extend the life of your upholstered panels, regularly dust the panel to prevent airborne particles from penetrating the fabric surface.

For light soiling, use a damp cloth and blot the spot with very slight pressure, taking care never to soak the fabric. Dry with a clean cloth by blotting - never rub fabric. More intense stains can be treated the same way, but with a mild detergent. Always test fabric first in an unseen area before using any cleaning method.

PANEL FRAMES

The panel frames are manufactured out of sturdy aluminum with a powder coated enamel paint finish. To clean the frames of the panels, and all hardware associated with the Evolve line, simply utilize a clean, damp cloth. For stubborn stains on the panel frames, you may consider adding a mild detergent.

GLAZED PANELS

Cleaning of the glazing in panels should only be done with a damp lint-free cloth. A mild detergent can be used if necessary. Do not use paper towels in combination with a window cleaner-this may cause scratches to the glazing.

WORKSURFACES

The worksurfaces are manufactured using primarily Nevamar Brand laminates as the exposed surface. To properly clean these areas, it is best to use a clean, damp cloth and circular motion to prevent streaks. For stubborn stains, you are able to add a mild detergent to the water. Be certain not to use an ammonia-based solution. It will react with the PVC, or wood edge trim, causing permanent damage to the contacted areas.

ACCESSORIES

The accessories sold with the Evolve product line can be simply cleaned with a clean, damp cloth. If they are really dirty, a mild, non-abrasive solution may be added. Wipe with a damp cloth after the solution, and finally, a dry cloth.

LAMINATES – THERMALLY FUSED & HIGH PRESSURE

Absolute Acajou*	ACJ
Asian Night*	ASN
Avant Cherry*	AWC
Avant Honey*	AWH
Black*	BLK
Blizzard*	BZD
Brushed Cobalt*	BRC
Clear Maple*	CMB
Custom Grey	CGY
Dark Espresso*	DES
Designer White*	DWT
Fashionista	FAS
First Class	FCL
Noce Biondo	(NBL)
Noce Grigio	(NGL)
Noce Leggero	(NEL)
Noce Medio	(NML)
Quartered Mahogany*	QTM
Sheer Beauty	SBY
Stone Dust	SDT
Storm Grey	SGG
Walnut Heights*	WHE
Winter Cherry*	WCR
White Chocolate*	WHC

Additional paint and laminates may be available. Contact Evolve Customer Support for details.

* Matching Wood Grain PVC edge available.

* PVC panel and connector trims are discontinued. Effective 12/2014

* 1 1/8" Worksurfaces are discontinued. Effective December 2014

PVC EDGE TRIM

Absolute Acajou	AAE
Asian Night	ASE
Avant Cherry	ACE
Avant Honey	AHE
Black	BLK
Blizzard	BZD
Brushed Cobalt	BRC
Charcoal	CHR
Clear Maple	CME
Dark Espresso*	DES
Designer White	DWE
Fashionista	FAS
First Class	FCL
Nevada	NEV
Quartered Mahogany*	QTM
Sheer Beauty	SBY
Silver	SIL
Taupe	TPE
Tungsten	TUN
Walnut Heights	WHE
Winter Cherry*	WCR
White Chocolate*	CBE

* 1 7/16" HPW PVC Trim for Worksurfaces is not available in Dark Espresso (DES).

WOOD VENEER WORKSURFACES*

Almond Cherry	AMW
Amber Cherry	ACW
Biscotti	BTW
Cocoa Walnut	CAW
Coral	CRW
Dark Cherry	DCW
Dark Walnut	DWW
Espresso Walnut	EWV
Evening Oak	EWW
Grey on Oak	GRW
Hazlenut	HAW
Java	JAW
Latte Walnut	LTW
Mahogany on Walnut	MHW
Milestone	MTW
Natural Maple	MPW
Natural Walnut	NLW
Red Cherry	RCW
Umber Walnut	ULW
Vintage Cherry	VNW
Walnut	WLW
Warm Cherry	WCW
White Maple	WMW

All wood veneer worksurfaces are 1.38" thick.

*Note: Wood veneer options for worksurfaces are available at an up charge and with an extended lead time. Contact Evolve Customer Support for details.

STANDARD PAINT & FRAME COLORS

(for application to trim, steel components, PVC, vertical and horizontal members)

Black	BLK
Blizzard (Textured)	BZD
Charcoal	CHR
Designer White	DWT
Fog	FOG
Nevada	NEV
Silver	SIL
Stone Dust (Textured)	SDT
Taupe	TPE
Tungsten°	TUN

Additional paint and laminates may be available. Contact Evolve Customer Support for details.

°Tungsten paint is subject to 10% upcharge EXCEPT on Worksurfaces, PVC items, or when PVC trim components are ordered separately.

PREMIUM PAINT & FRAME COLORS

Black Coffee*	BKC
Bone*	BNE
Business Grey*	BGR
Claret*	CLT
Dark Chocolate*	DCH
Desert Putty*	DPT
Grey*	GRY
Ice*	ICE
Ivory*	IVR
Light Grey*	LGR
Metro*	MET
Mocha*	MCH
Moss*	MOS
Navy*	NVY
Oyster*	OYS
Sky*	SKY
Stone*	STN
Storm Grey	SGR
Tahiti Sand*	TSA
Willow*	WIL

*Premium paint selections are available on the following components: Panels (top trim and frame), Hardware, End-of run/Post Kits, and Accessories at a 22% upcharge. Storage with no upcharge.

*Please note all Double Wall Storage units must be ordered in a minimum quantity of 50 when ordering in a premium paint finish. Different model types can be combined to achieve the minimum quantity required. See pages 192-193 for affected models.

All special and premium paint match orders of 50 panels or less will incur a \$500 net setup fee. Panels, hardware, accessories and storage may be combined on orders to achieve minimum of 50 pieces or more and will not be subject to \$500 net set up fee. Add on orders will not have that charge for 90 days after the original order has shipped and must have the original PO# quoted otherwise they will not qualify for the program.

Global matte paint finishes are available on most Evolve Storage pieces without an up charge regardless of quantities.

All Mica and Metallic paint finishes will incur a minimum up charge of 10%.

All non-standard paint finishes must be approved by Evolve prior to placing an order.

ADA Overheads are not available in Evolve premium color paints. ADA Overheads are available in Evolve standard paint colors only.

Frames for all Open Panel models, all panel retainers, PVC components for panels and connectors are unavailable in premium or special/custom paint colors. They are available in standard Evolve paint colors only.

PANEL FABRICS – GRADE 1

Anchorage - 35% Post - consumer Recycled Polyester and 65% Pre -consumer Recycled Polyester

Birch	AN40
Green Apple	AN41
Lapis	AN42
Straw	AN43
Wolf	AN44
Goose	AN45
Angora	AN46
Cumin	AN47
Asteroid	AN48
Geranium	AN49
Thistle	AN50
Graphite	AN51
Slate	AN52
Quarry Blue	AN53
Onyx	AN54
Pumpkin	AN55
Red Delicious	AN56
Sunshine	AN57
Waterfall	AN59
Vanilla	AN61
Vanilla	AN61
Cobalt	AN62
Cloud	AN64

Aurora - 100% Polyester, 80% minimum Post-Consumer Recycled Polyester

Cloud	AU20
Seal	AU21
Fog	AU22
Pewter	AU23
Granite	AU24
Oat	AU25
Coconut	AU26
Latte	AU27
Lake	AU28
Frost	AU29

Ease - 100% Recycled Polyester,

Stratus	EZ24
Pebble	EZ25
Glow	EZ26
Bloom	EZ27
Earthbound	EZ28
Nebula	EZ29
Terrain	EZ30
Fog	EZ32
Glacial	EZ33
Evening	EZ34

Expanse - 100% Post-Consumer Recycled Biodegradable Polyester

Sand	AX42
Vapor	AX43
Steel	AX44
Cinder	AX45
Morel	AX46
Driftwood	AX47
Hazel	AX48
Seed	AX49
Mineral	AX50
Breeze	AX51

Linea - 100% Post Consumer Recycled Polyester

Queue	LN41
Cord	LN42
Twine	LN43
Thread	LN44
Contour	LN45
Silhouette	LN46
Cable	LN47
Route	LN48

Lisbon - 80% Polyester, 20% Post-Consumer Recycled Polyester

Gesso	LS11
Dusk	LS12
Grey	LS13
Ivory	LS14
Henna	LS15
Nocturnal	LS16
Moss	LS17
Navy	LS18
Buff	LS19
Spa	LS20

Loopy - 100% Recycled Polyester

Oyster	LP60
Putty	LP61
Marble	LP62
Hazelnut	LP63
Latte	LP64
Bay	LP65
Wild Rice	LP66
Harbor	LP67

Melody - 100% Recycled Polyester

Spray	ME40
Pond	ME41
Sand Bar	ME42
Silt	ME43
Pebble	ME44
Lake	ME45
Gravel	ME46
Boulder	ME47

Merge - 100% Polyester, 75% minimum Post-Consumer Recycled Polyester

Fawn	MG20
Marshmallow	MG21
Driftwood	MG22
Dove	MG23
Graphite	MG24
Slate	MG25
Eucalyptus	MG26
Fire Engine	MG27
Mediterranean	MG28
Midnight	MG29

Pinpoint - 100% Post-Consumer Recycled Polyester

Bliss	PN11
Delight	PN12
Dune	PN13
Infusion	PN14
Ebony	PN15
Fresh	PN16
Carrot	PN17
Splash	PN18
Vibe	PN19
Gala	PN20

Streak - 100% Recycled Polyester

Beach	SR81
Shade	SR86
Stretch	SR88
Sprint	SR89
Roll	SR91
Dart	SR92
Zoom	SR93
Splash	SR94
Whiz	SR95
Flash	SR96

Tek - 100% Recycled Polyester

Finesse	TX60
Grain	TX61
Essence	TX62
Warp	TX64
Mesh	TX67
Form	TX69
Spice	TX71
Glacier	TX72
Spring	TX73
Harmony	TX74
Smoke	TX75
Pebble	TX76

Terrace - 100% Post-Consumer Recycled Polyester

Lotus	TC60
Tigerlily	TC61
Shadow	TC62
Cobble	TC63
Cherry Blossom	TC64
Bluebell	TC65
Apple	TC66
Haze	TC67
Cerise	TC68
Twilight	TC69
Wintergreen	TC70
Ironwork	TC71
Flirt	TC73
Echo	TC74
Glacier	TC75

PANEL FABRICS— GRADE 2

Cyclone - 56% post-consumer recycled polyester and 44% polyester.

Stove Pipe	IM37
Stainless.....	IM40
Polished Pewter	IM41
Welded Steel	IM43
Etched Bronze.....	IM44
Fired Titanium.....	IM46
Chrome.....	IM49
Dark Annealed.....	IM50
Karat.....	IM54
Red Metal.....	IM55
Oxidized Bronze.....	IM56
Bright Ray.....	IM57
Bismuth Crystal	IM58
Gallium Blue.....	IM59

Dashing -100% Post-Consumer Recycled Polyester

Classic Silver.....	DS21
Refined Marble.....	DS22
Antique Sage.....	DS23
Polished Slate	DS24
Genteel Beige	DS25
Bespoke Tan	DS26
Dapper Grey.....	DS27

PET PANEL FABRICS

Amethyst	GPH
Apricot.....	APR
Black.....	BLK
Blue Smoke	BSK
Brick.....	BRI
Carnation.....	CNN
Denim	DEN
Emerald	EMD
Graphite.....	GPH
Harvest.....	HVT
Lapis	LAP
Mist	MTS
Navy	NVY
Pewter	PWT
Ruby.....	RBV
Shamrock.....	SHR
Sunflower	SFR
White.....	WHT

GRADE 1

Dobby - 96% Recycled Polyester / 4% Virgin Polyester

Snowcap.....	DB30
Bonsai.....	DB31
Cloud.....	DB32
Sand.....	DB33
Pewter.....	DB34
Sante Fe.....	DB35
Corfu.....	DB36
Medium Taupe.....	DB37
Charcoal.....	DB38
Berry.....	DB39
Royal.....	DB40
Titanium.....	DB41
Black.....	DB42

Fusion - 90% Virgin Polyester/ 10% Post-Consumer Recycled Polyester

Tangerine.....	FU71
Fresh.....	FU72
Moss.....	FU73
TomatoF.....	FU74
Aqua.....	FU75
Sandstone.....	FU76
Granite.....	FU77
Poppy.....	FU78
Cadet.....	FU79
Oasis.....	FU80
Graphite.....	FU81
Viola.....	FU82
Cobalt.....	FU83
Flax.....	FU84
Carbon.....	FU85

Illusion - 100% Virgin Polyester

Cappuccino.....	II01
Paprika.....	II02
Tropic.....	II03
Wicker.....	II04
Hemp.....	II05
Cayenne.....	II06
Maui.....	II07
Dusk.....	II08
Smoke.....	II09
Currant.....	II10
Fiji.....	II11
Ozone.....	II12
Ebony.....	II13

Jenny - 100% Polyester

Midnite.....	JN01
Ebony.....	JN02
Slate.....	JN03
Vermilion.....	JN07
Admiral.....	JN08
Charcoal.....	JN11
Silver Lining.....	JN25
Oatmeal.....	JN26
Sunflower.....	JN27
Cascade.....	JN28
Harvest.....	JN29
Mellon.....	JN30
Berry.....	JN31
Green Grass.....	JN32
Roast.....	JN33

Quilt - 100% Polyester

Black.....	QL10
Charcoal Grey.....	QL11
Navy.....	QL14
Wine.....	QL16
Silver.....	QL19
Feather.....	QL20
Dune.....	QL21
Meadow.....	QL22
Cadet.....	QL23
Geranium.....	QL24
Daisy.....	QL25
Quest.....	QL26
Punch.....	QL27
Tangerine.....	QL28
Cocoa.....	QL29

Terrace - 100% Post-Consumer Recycled Polyester

Lotus.....	TC60
Tigerlily.....	TC61
Shadow.....	TC62
Cobble.....	TC63
Cherry Blossom.....	TC64
Bluebell.....	TC65
Apple.....	TC66
Haze.....	TC67
Cerise.....	TC68
Twilight.....	TC69
Wintergreen.....	TC70
Ironwork.....	TC71
Pine Cone.....	TC72
Flirt.....	TC73
Echo.....	TC74

Trak - 100% Recycled Polyester

Taupe.....	TK40
Mustard.....	TK41
Latte.....	TK42
Cement.....	TK43
Silver.....	TK44
Copper.....	TK45
Teal.....	TK46
Apple.....	TK47
Steel.....	TK48
Merlot.....	TK49
Midnight Sky.....	TK50
Mocha.....	TK51
Carbon.....	TK52

Urban - 62% Recycled Polyester / 32% Polyester

Ocean Blue.....	UR11
Blue Bayou.....	UR12
Green Grass.....	UR13
Brown Ridge.....	UR18
White Sand.....	UR19
Granite Rock.....	UR20
Gravel Road.....	UR21
Black Coal.....	UR22

Waterfall - 60% Virgin Polyester /40% Post - Consumer Recycled Polyester

Trance.....	WA40
Tryst.....	WA41
Splash.....	WA42
Victoria.....	WA43
Imagine.....	WA44
Sky.....	WA45
Rainforest.....	WA46
Rumble.....	WA47
Prism.....	WA48
Tranquility.....	WA49
Grand.....	WA50
Rushing.....	WA51
Majestic.....	WA52
Pacific.....	WA53
Dance.....	WA54

Waterfall - 60% Virgin Polyester /40% Post - Consumer Recycled Polyester

Lime.....	WV01
Mint.....	WV02
Stone.....	WV03
Flame.....	WV04
Mykonos.....	WV05
Savannah.....	WV06
Mesa.....	WV07
Plasma.....	WV08
Cancun.....	WV09
Quartz.....	WV10
Moonrock.....	WV11
Rubine.....	WV12
Corfu.....	WV13
Bluejay.....	WV14

GRADE 2 (FABRIC)

Imprint - 100% Post-Consumer Polyester

Almond.....	IM70
Cork.....	IM71
Sand.....	IM72
Currie.....	IM73
Candy Apple.....	IM74
Ocean.....	IM75
Navy.....	IM76
Green Tea.....	IM77
Celery.....	IM78
Oregano.....	IM79
Walnut.....	IM80
Paprika.....	IM81
Graphite.....	IM82
Slate.....	IM83
Licorice.....	IM84

GRADE 2 (VINYL)

For availability of chair series in Vinyl, please contact a Global Sales Representative.

Allante FRee - 100% Vinyl Face / 100% Polyester Backing

Illusion	A01F
Bright White	A02F
White Crush	A03F
Ivory	A04F
Ice	A05F
Bleached Sand	A06F
Taupe Fawn	A07F
Warm Smoke	A08F
Autumn Rain	A09F
Cookie	A10F
Sierra Brick	A11F
Gibraltar	A12F
Chateau Grey	A13F
Golden Green	A14F
Oasis Green	A15F
Ink Black	A16F
Purple impulse	A17F
Italian Rose	A18F
Mountain Sky	A19F
Old Navy	A20F
Galaxy	A21F
Red Truffle	A22F
Chocolate Sundae	A23F
Province Blue	A24F
Eclipse	A25F

GRADE 3 (RECYCLED)

Couture - 100% Post-Consumer

Polyester	
Mocha	CE71
Sapphire	CE74
Neptune	CE75
Lake	CE76
Willow	CE77
Sassy	CE78
Persimmon	CE80
Carbon	CE81
Sterling	CE82

PANEL C.O.M REQUEST FOR APPLICATION TEST

SEND COMPLETED FORM AND FABRIC TO:

Evolve Furniture Group
555 rolia Road
Toronto, Ontario M3J2X8
Attn: Nahum Schneider

Requested By: _____

Phone #: _____

Fax #: _____

Product Name _____

Dealer/Specifier _____

Dealer Contact: _____

Evolve CSR: _____

Phone #: _____

Fax #: _____

FABRIC INFORMATION

Fabric Manufacturer: _____

Color Name: _____

Color #: _____

Pattern Name: _____

Pattern #: _____

Content: _____

Weight: _____

Width: _____

Repeat Horizontal: _____

Repeat Vertical: _____

Other Comments: _____

REQUEST FOR APPLICATION TEST (THIS REQUIRES 2 YARDS OF FABRIC)

_____ Evolve Panel

_____ Evolve Tackboard

_____ OH Doors

Total Number of yards for testing: _____

Please Note:

Evolve is not responsible for the duty and brokerage fees for C.O.M. Fabric to clear customs. These charges will be billed to the dealer on a separate invoice.

PANEL FABRIC SPECIFICATION SHEET

SEND COMPLETED FORM TO:

EVOLVE Furniture Group
 555 rolia Road
 Toronto, Ontario M3J2X8
 Attn: Nahum Schneider

SUPPLIER PATTERN WIDTH CONTENT	REMARKS: _____ _____ _____ _____	
LIGHT FASTNESS FLAMMABILITY TUNNER TEST	REMARKS: _____ _____ _____ _____	
CUT PRICE 1 - 3 ROLLS 4 ROLLS	REMARKS: _____ _____ _____ _____	
DIRECTIONAL PANELS CORNERS RACEWAY COVER RACEWAY CORNERS STRETCH	REMARKS: _____ _____ _____ _____	EASY HARD X-HARD
APPROVED <input type="checkbox"/> NOT APPROVED <input type="checkbox"/> CONDITIONAL APPROVAL <input type="checkbox"/>		
REMARKS: _____ _____ _____		
<p><small>* This fabric is approved for upholster-ability only. The approval does not account for the durability of the fabric at the time of, and after installation of the product</small></p>		
SIGNATURE: _____ PRINT NAME: _____ DATE: _____		

TOP

**STAPLE
MINIMUM 6" X 6"
FABRIC SAMPLE HERE
IN THE DIRECTION IT IS TO BE
APPLIED TO THE PRODUCT**

BOTTOM

APPENDIX

The Evolve Furniture Group has partnered with the software vendors listed below to provide you with an online source for viewing the 2014 Evolve Electronic Catalog. Please visit their websites for additional information and download details.

2020 Technologies

www.2020technologies.com
5503 Mile Road NW
Grand Rapids, MI 49544
Phone: 800-638-6002

Ice Edge Business Solutions

www.ice-edge.com
4001 S 700 East, Suite 450
Salt Lake City, UT 84107
Phone: 801-747-0373

KISP

www.kisp.com
Customer Support: 416-499-2457
Cad Services Team: 416-499-2457 x3
Customer Service e-mail: tellmemore@kisp.com
CAD Services requests CadServices@kispstech.com

Project Matrix

www.projectmatrix.com
11655 Lebanon Rd.
Cincinnati, OH 45241
Tech Support Instant Messenger: projectmatrixtech@yahoo.com
Phone: 513.554.1665
Fax: 513.554.1255

Quintero-Smith Incorporated/Midnight Oil

www.midnight-oil.com
10469 Kinnard Avenue
Los Angeles, CA 90024
voice: 800-350-7434 (US Only)
international: 310-478-5140
fax: 310-478-4572
e-mail: jimsr@q-si.com

TERMS & CONDITIONS

APPLICATION OF STANDARD TERMS

Sales of Evolve products are made only on Evolve standard terms and conditions of sale which are contained in the Price Book and in Evolve's order acknowledgments. These standard terms and conditions may be modified or supplemented only by a separately written document signed by Evolve's authorized personnel at its head office in Marlton, New Jersey. An offer by Purchaser of said terms and conditions shall not be binding until accepted by Evolve in writing.

All illustrations, specifications and prices in this Price List are based on the latest product information available at the time of publication. Evolve reserves the right to make changes, at any time and without prior notice, to prices, colors, materials, specifications and models offered.

PRICES AND PAYMENT

The prices shown in this Price List, as well as those quoted by Evolve, shall be in US dollars for orders shipped to destinations within the continental United States.

Prices listed herein are for standard product. Quotations for special product are available through Evolve Customer Support Department in Marlton, New Jersey.

If shipping date requested is more than 90 days from date of order Evolve shall use published list prices effective at the time of shipment.

Not included in the list price are special or export packing, unpacking and installation. Orders are invoiced at the time of shipment. The Customer agrees to pay a charge of 2% per month of invoices outstanding more than 30 days.

FOR PAYMENTS ONLY, MAIL TO:

Evolve Furniture Group, a division of:
Global Industries, Inc.
17 West Stow Road
P.O. Box 562
Marlton, New Jersey 08053

Any products sold shall remain the property of Evolve until fully paid for in cash. The Purchaser agrees to perform all acts which may be necessary to perfect and assure retention of title to such products to Evolve until such time as the goods have been paid for in full.

Free freight applies to orders dock delivered to one commercial business location in the contiguous United States during normal business hours. Residential deliveries will incur additional delivery charges.

Please note exception below:

All showroom and mock-up orders will be subject to actual freight charges.

Evolve shall, in its sole discretion, determine the most appropriate method of shipment routing and carrier. Shipments of less than a full trailer load (LTL) shall ship via common carrier. **These LTL shipments are not subject to specific delivery days or times.** Full trailer loads will provide for dedicated delivery time and schedule. Purchaser may request special packaging or method of shipment at Purchaser's sole expense.

TAXES

All sales, use, excise and other applicable taxes and the collection and reporting thereof (excluding only taxes on the net income of Evolve) are the Purchaser's responsibility and will be invoiced to the Purchaser. If Purchaser claims an exemption from such taxes, it shall be the Purchaser's responsibility to furnish an appropriate exemption certificate to Evolve.

ORDER INFORMATION

Evolve requires that **all orders be submitted in writing** to avoid errors and/or duplication. Orders will be acknowledged with Evolve's acknowledgement forms governing the transaction. The details appearing on the acknowledgement will describe the items to be shipped to Purchaser who must ascertain that they are correct. If not correct, Purchaser should notify Evolve immediately by telephone or fax followed by written confirmation. Acknowledgment shows approximate shipping date of items ordered. **Shipping dates are assigned to orders based on the item having the longest manufacturing lead time.** Orders with Customer's Own Material (C.O.M.), or missing or incorrect information (finish selections, fabric selections, etc.) will be scheduled for manufacturing upon receipt of COM or correct complete information. Purchaser must indicate if multiple shipping schedules are required including noting if the shipping date requested is longer than standard posted lead time. Each shipment will be invoiced at time of shipping and will be subject to payment terms described herein.

C.O.M. CUSTOMER'S OWN MATERIAL

Should Purchaser request a fabric, not standard to the Evolve upholstery line, Purchaser shall submit a sample of not less than two yards for approval. Evolve will determine whether fabric is suitable to manufacturing process and applicable UL or code requirements. Should Evolve be required to test such fabric, it shall so advise Purchaser, and Purchaser shall be responsible for all costs associated therewith. This includes all duty and brokerage fees.

Fabric yardage requirement will be determined by Evolve. An additional charge may be made to cover the cost of cutting, matching or sewing unusual or directional patterns. Evolve shall have no responsibility for condition, quality, performance, physical properties or any other aspect of C.O.M. For panels, price as if grade 1 fabric is used.

Evolve reserves the right to reject any C.O.M. deemed unsuitable.

Evolve reserves the right to cancel an order at any time if C.O.M. is, in the sole judgement of Evolve, inadequate for any reason.

CHANGES AND CANCELLATION

The order may not be changed or cancelled by Purchaser without the written consent of Evolve. This charge can be as much as 100% based upon proximity to scheduled shipment date. Special order items and fabric-covered items already in production are not subject to change or cancellation under any circumstances. Fabric-covered items are considered to be in production once the fabric has been cut.

DEPOSIT ON SPECIAL ORDERS

Orders for nonstandard products may, at Evolve's discretion, require deposit prior to scheduling of production, the amount of the deposit being credited against the total price of the project.

SUSPENSION

In the event that the Purchaser defaults in the payment of any sum due Evolve, or in the event the Purchaser's financial condition becomes unsatisfactory to Evolve, Evolve shall have the right at its option, upon written notice to the Purchaser, to cancel shipment of any goods, unless within ten (10) days of Purchaser's receipt of such notice Purchaser provides assurance of payment to Evolve in such form, content and/or amounts as Evolve, in its sole discretion, deems adequate.

COMBINED SHIPMENTS

Evolve will make every effort to combine shipments and orders on written request. However, acceptance of such request shall be with Evolve's sole discretion.

CODE RESTRICTIONS

Evolve portable furniture may be subject to local fire, electrical and/or building codes applicable to portable furniture. It shall be Purchaser's sole responsibility for the proper application of Evolve items within the limitations of such local codes, which may be different from area to area.

SERVICE

Service problems shall be handled by the authorized Evolve dealer. Where this cannot be accomplished on a local level, service problems should be referred to:

Evolve Furniture Group
Customer Support
17 West Stow Road
Marlton, New Jersey USA 08053
856-552-4000 888-827-2500
Attention: Evolve Operations Manager

TERMS & CONDITIONS

STORAGE

In the event Purchaser requests postponement of delivery beyond the acknowledged shipping date, Evolve may transfer the goods to storage on Purchaser's account and at Purchaser's risk and expense subject to a daily storage rate. Such transfer to storage shall be deemed shipment to Purchaser for all purposes, including invoicing and payment.

DELAYS

Evolve's order acknowledgement will state a shipping date which is Evolve's best estimate at the time the order is acknowledged. However, Evolve shall not incur any obligation or liability to Purchaser for failure to ship by a specified date. In addition, Evolve shall not be liable for any loss or damage resulting from any delay or failure in shipment or other failure to perform all or any part of the agreement between the parties with respect to the goods shown on the face of the order acknowledgement where such delay, failure, loss or damage is the proximate result of any act of any governmental authority or political subdivision thereof, revolution, riot, civil disorder or disturbance, act of enemies, delay or default in transportation, strike disputes among or between unions or other labor disputes, delay or inability in obtaining materials and facilities, fire, flood, act of God or any cause not within the reasonable control of Evolve, whether of the class of causes enumerated or otherwise. Without limiting the generality of the foregoing, Evolve may, without causing any breach or incurring liability, allocate goods which are in short supply, regardless of the reasons therefore, among purchasers, in any manner which Evolve, in its sole discretion, deems advisable.

BACK CHARGES

Evolve will not accept charges for expense incurred by the Purchaser in expediting shipments or otherwise. Evolve will not accept charges for the repair of damage by others.

CLAIMS

All goods are sold F.O.B. Toronto, Canada, unless otherwise agreed to in writing by Evolve. Evolve is not responsible for damage which occurs in transit or in storage. The carrier signs for all goods received in good order. It is the Purchaser's responsibility to examine goods upon receipt and to file any claims with the carrier. Any claims made against Evolve for apparent defects, errors or shortages must be made by the Purchaser in writing, within fifteen (15) working days after any delivery. Failure by the Purchaser to make any claim against Evolve within the above-described fifteen days shall constitute acceptance of the goods and a waiver of any apparent defects, errors or shortages.

RETURNS

No returns of goods will be accepted without written consent and shipping instructions, including Evolve's Return Goods Authorization (R.G.A.) numbers, to Evolve. A minimum restocking charge of 35% is made on all authorized returns for credit or refund, provided goods are received by Evolve in the condition in which they left the factory. No credit will be given if goods cannot be reused. Special order items and fabric-covered items are in no event subject to return. All returns must be approved and authorized in writing by Evolve Customer Support, Marlton, New Jersey.

LIFETIME WARRANTY

Evolve warrants that all commercial products are free from defects in material and workmanship, for the life of the product, to the original purchaser. This warranty is made by Evolve only to original customers acquiring the product directly from Evolve's authorized dealers. The customer's sole remedy pursuant to this warranty is limited to repair or replacement of parts or product at Evolve's option. Consent from Evolve must be obtained before any warranty work is performed. This warranty shall not apply to any products which must be replaced because of normal wear and tear, negligence, abuse or "accident", shipping damage, or product use and installation other than in accordance with written instructions or warnings. It shall also not apply when product has been modified or altered, repaired or refurbished by someone other than Evolve or an authorized dealer or because of natural variations over which Evolve has no control. In the event of repair and/or replacement of any defective product, Evolve does not warrant matching color, grain, texture or dye lots. Evolve's warranty does not cover the cost of transportation or labor. Repair or replacement will be at Evolve's option. Evolve makes no warranty that any of its products are suitable for any particular purpose and makes no other warranties, expressed or implied, other than those set forth in this Price List. As codes and standards vary from one jurisdiction to another, references to compliance are solely for convenience and without any representation as to accuracy or suitability. Users must verify the suitability of such information or product for their specific application. In no event shall Evolve be liable in either tort or contract for any loss or direct, special, incidental, consequential, or exemplary damages.

This Lifetime Warranty is NOT applicable to customers who use Evolve products for rental purposes and is effective only for products, parts or components manufactured after January 1, 2011.

Exceptions to this warranty include:

- Global fabrics and wood veneers, which are warranted for five years from date of delivery.
- Electrical components, which are warranted for ten years from the date of delivery.
- Moving parts such as glides, slides, casters, user-adjustable worksurface mechanisms, which are warranted for five years from date of delivery.

- Fading on fabric and wood veneers can be caused by exposure to U.V. rays/sunlight. Natural wood veneer, being a natural material, will have shade differences between veneer sheers, the difference will be more apparent between dye lots.

Evolve does not warrant color fastness on Customer's Own Material.

Because of natural variations over which Evolve has no control, this warranty does not extend to color, grain or texture of wood, and Evolve does not warrant matching of color, grain or texture.

Evolve makes no warranties, including implied warranties of merchantability and fitness for a particular purpose, other than the express warranties contained herein.

LIMITATION OF REMEDY

Purchaser's sole and exclusive remedy (excluding the repair or replacement of goods for breach of the express warranty above) for any matter or claim arising under or relating to these terms and conditions, the goods covered hereby and any transaction involving or relating to such goods, whether in contract, tort (including negligence) or otherwise, shall be payment of the lesser of the cost to repair or replace said product or the purchase price for the goods to which the claim relates. In no event shall Evolve be liable for any special, indirect, consequential, or incidental damages, including without limitation, damages for loss of business profits, business interruptions, or loss of information.

EVOLVE'S WARRANTY DOES NOT APPLY (FOR ANY PRODUCT CATEGORY) TO THE FOLLOWING:

- Failures due to wear and tear
- Failures which result from negligence, abuse, accident or misuse
- Failure to apply, install or maintain products according to Evolve's written instructions and warnings
- Modifications, attachments or repair methods not approved by Evolve
- Damage caused by a carrier in transit, or delivery/installation contractors
- The matching of colors, grains or textures (wood, leather, etc.) of natural materials and color matching of textiles
- Products exposed to extreme hot or cold temperatures or excessively dry or humid environments
- Colorfastness or the matching of color of textiles
- Damage by markings or staining; damage by sharp objects or imprinting from instruments
- Damage to textiles or laminate and wood surfaces/edges from exposure to sunlight (including UV rays)
- Products used for rental purposes

Evolve's warranty applies to products sold within the United States of America, Mexico, the Commonwealth of Puerto Rico and Canada.

Global US Headquarters/Distribution Center

17 West Stow Road, P.O. Box 562
 Marlton, New Jersey U.S.A. 08053
 T (856) 596-3390
 T (800) 220-1900

Showrooms

Atlanta

10 10th Street
 Suite 150
 Atlanta, GA 30309
 T (404) 879-0998

Boston

One Harbor Street
 Suite 104
 Boston, MA 02210
 T (617) 406-5435

Chicago

1045 W Fulton Street
 Chicago, IL 60607
 T (312) 755-0843

Irvine

18400 Von Karman Ave.
 Suite 100
 Irvine, CA 92618

Miami

112 NE 41st Street
 6th Floor
 Miami, FL 33137

New York City

386 Park Avenue South
 7th Floor
 New York, NY 10016
 T (212) 545-9900

Philadelphia

1735 Market Street
 38th Floor
 Philadelphia, PA 19103
 T (215) 861-0963

New Jersey (Southern)

119 West Greentree Road
 Marlton, NJ 08053
 T (856) 596-3390

Phoenix

4675 E Cotton Center Blvd.
 Suite 165
 Phoenix, AZ 85040
 T (602) 426-0666
 T (602) 426-0777

Washington, DC

1130 Connecticut Avenue
 10th Floor, Suite 1000
 Washington, DC 20036
 T (202) 659-0230
 T (202) 659-0236

Distribution Centers

Atlanta Area

6715 Maple Ave.
 Suite 100
 Buford, GA 30518
 T (678) 602-4130

Baltimore Area

Troy Hill
 Corporate Center
 7030 Troy Hill Drive
 Elkridge, MD 21075
 T (410) 379-8021

Chicago Area

27W501 North Ave.
 Suite 300
 West Chicago, IL 60185
 T (630) 681-2818

Cincinnati Area

8712 LeSaint Drive
 Fairfield, OH 45014
 T (513) 777-0009

Dallas Area

2025 West Beltline Road
 #100
 Carrollton, TX 75006
 T (972) 236-1366

Denver Area

19080 E. 38th Ave.
 Unit #30
 Aurora, CO 80011
 T (303) 340-1617

Ft. Lauderdale Area

560 Sawgrass
 Corporate Pkwy
 Sunrise, FL 33325
 T (954) 846-8888

Houston Area

7865 Northcourt Road
 Suite 200
 Houston, TX 77040
 T (713) 695-5777

Los Angeles Area

3629 Workman Mill Road
 Whittier, CA 90601
 T (562) 484-9686

Philadelphia Area

181 Walter A Gaines Way
 Suite 200
 Lawnside, NJ 08045
 T (856) 596-3390

Seattle Area

Oakesdale Commerce Ctr.
 820 Southwest 34th Street
 Building W7, Suite A
 Renton, WA 98057
 T (425) 291-9282

Kansas City Area

11617 West 81st Street
 Lenexa, KS 66214
 T (913) 310-9963

Tampa Area

10351 Windhurst Road
 Tampa, FL 33619
 T (813) 621-6272



Global - USA Headquarters

17 West Stow Road P.O. Box 562
 Marlton, New Jersey U.S.A. 08053
 Tel (856) 596-3390 (800) 220-1900
 Fax (856) 596-5684
 www.globalfurnituregroup.com

Global - Canada Headquarters

1350 Flint Road
 Downsview, ON Canada M3J 2J7
 Sales & Marketing: Tel (1-877) 446-2251
 Customer Service: Fax (800) 361-3182
 Government Customer Service: Fax (416) 739-6319

